

1. Dimensions, structure and materials

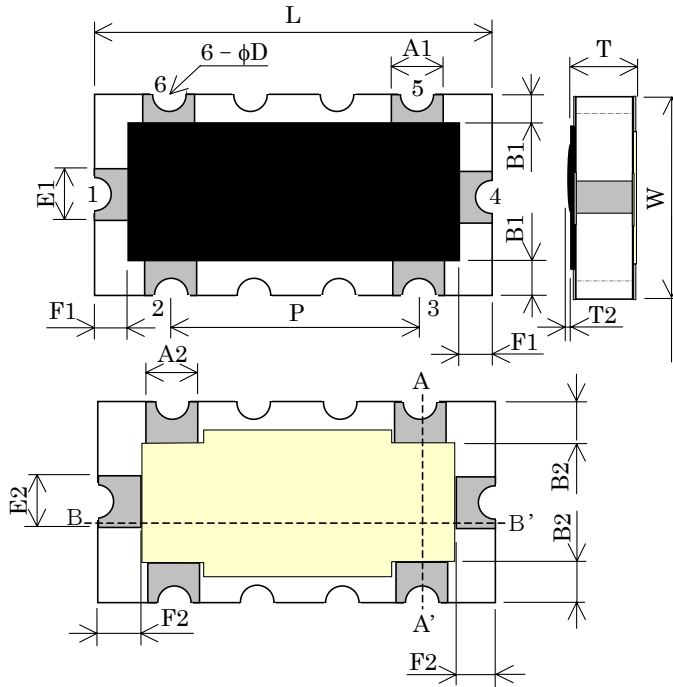

	L	W	T1	A1	B1	E1	F1
Dimensions (mm)	3.20±0.15	1.60±0.15	0.55±0.15	0.40±0.15	0.20±0.15	0.40±0.15	0.20±0.15

	A2	B2	E2	F2	P	D
Dimensions (mm)	0.40±0.15	0.38±0.15	0.40±0.15	0.35±0.15	1.905 ±0.300	0.20±0.15

A-A' Sectional plan

B-B' Sectional plan

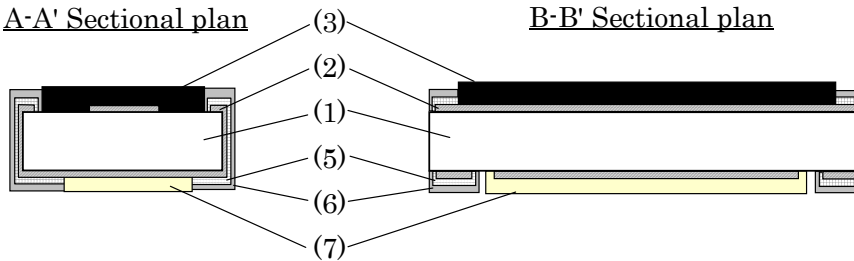

	Name	Material
(1)	Substrate	Alumina
(2)	Termination (Inner)	Ag
(3)	Protective coating(Top)	Epoxy resin(Black)
(4)	Protective coating(Bottom)	Epoxy resin(White)
(5)	Termination (Between)	Ni plating
(6)	Termination (Outer)	Sn plating

Classification	No.
Chip RF Jumper PRODUCT SPECIFICATION FOR INFORMATION	151-XB-JP00BE
Subject	12 - 11
EXBD6JP000A	

2. Specifications

Item	Specification
Resistance(between 1-4 terminal)	50 mΩ max.
Isolation (2.5 GHz)	-40 dB max.
Return loss (2.5 GHz)	-20 dB max.
Insertion loss (2.5 GHz)	-0.5 dB min.
Rated current 1)	1 A
Maximum rated current	2 A
Number of Terminals	6 Terminals
Category temperature range	-55 °C to +125 °C

- 1) Derating curve
For jumpers operated in ambient temperature above 70 °C, rated current shall be derated in accordance with 3. Derating curve

3. Derating curve for high ambient temperature

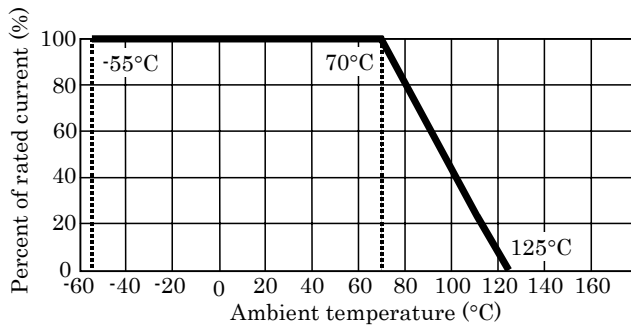

4. Explanation of part number

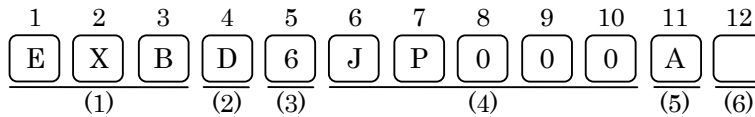

- (1) Product code: Thick film resistor network
 (2) Dimension code of chip resistor network: 3.2 mm × 1.6 mm
 (3) Number of terminals: 6 terminals
 (4) Circuit configuration
 (5) Characteristics impedance

Code	Circuit configuration
JP000	RF jumper circuit (Signal terminal: 1, 4, GND terminal: 2, 3, 5, 6)

Code	Characteristic impedance
A	50 Ω

- (6) Code for special requirements

5. Circuit

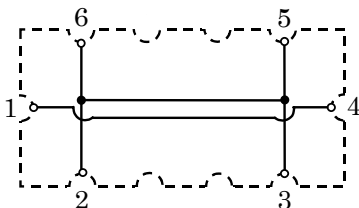

Classification	Chip RF Jumper PRODUCT SPECIFICATION FOR INFORMATION	No. 151-XB-JP00BE
Subject	EXBD6JP000A	12 - 12

6. Performance specification

6.1. Standard environmental condition

Unless otherwise specified, ambient atmosphere at performance tests and measuring shall meet the following conditions.

Ambient temperature: $25\text{ }^{\circ}\text{C} \pm 2\text{ }^{\circ}\text{C}$, Relative humidity: 45 % to 75 %,

Atmosphere pressure: 86 kPa to 106 kPa

6.2. Test method

Unless otherwise specified, the board, the land pattern, the flux, the solder and the soldering method in performance tests shall be subjected to “7. Precaution for mounting”.

6.3. Electrical performance

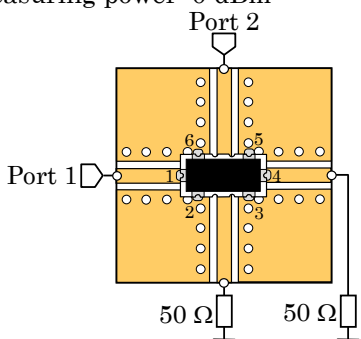
Characteristics	Specification	Test method
6.3.1. Resistance	50 mΩ max.	Resistance value measured by four – point probe method at the test current of 10 mA to 100 mA. The measurement system shall be accurate sufficiently.
6.3.2. Isolation	-40 dB max. (2.5 GHz)	Specimens shall be measured at the test circuit specified below. Measuring board: the attached drawing Measuring equipment: network analyzer Measuring parameter: s parameter(S21) Measuring power: 0 dBm 

Classification	Chip RF Jumper PRODUCT SPECIFICATION FOR INFORMATION	No. 151-XB-JP00BE
Subject	EXBD6JP000A	12 - 13

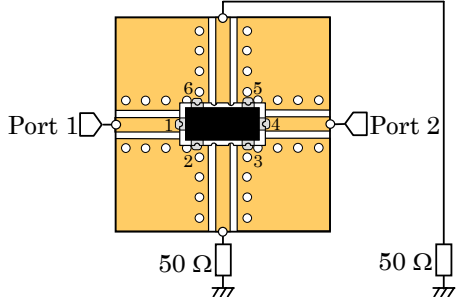
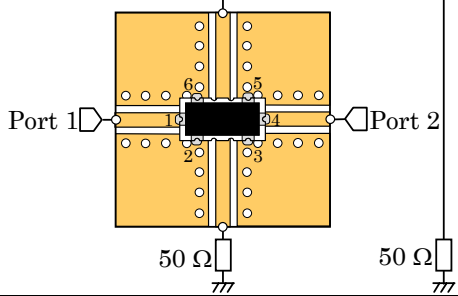
Characteristics	Specification	Test method
6.3.3. Return loss	-20 dB max. (2.5 GHz)	<p>Specimens shall be measured at the test circuit specified below.</p> <p>Measuring board: the attached drawing Measuring equipment: network analyzer Measuring parameter: s parameter (S11) Measuring power: 0 dBm</p> 
6.3.4. Insertion loss	-0.5 dB min. (2.5 GHz)	<p>Specimens shall be measured at the test circuit specified below.</p> <p>Measuring board: the attached drawing Measuring equipment: network analyzer Measuring parameter: s parameter (S21) Measuring power: 0 dBm</p> 
6.3.5. Insulation resistance	1000 MΩ min.	Insulation resistance shall be measured at DC 25 V between the terminal and the protective coating.

Classification	Chip RF Jumper PRODUCT SPECIFICATION FOR INFORMATION	No. 151-XB-JP00BE
Subject	EXBD6JP000A	12 - 14

6.4. Environmental performance

Characteristics	Specification	Test method															
6.4.1. Rapid change of temperature	50 mΩ max.	Specimens shall be tested for 700 cycles continuously in accordance with the following duty cycle. * Prior to use, verify the performance, reliability, etc. thoroughly, if you use the board that is not glass-fabric based epoxy resin. <table border="1"> <thead> <tr> <th>Step</th> <th>Temperature</th> <th>Time</th> </tr> </thead> <tbody> <tr> <td>1</td> <td>-40 °C ± 3 °C</td> <td>40 min ± 3 min</td> </tr> <tr> <td>2</td> <td>room temperature</td> <td>3 min max.</td> </tr> <tr> <td>3</td> <td>+85 °C ± 3 °C</td> <td>40 min ± 3 min</td> </tr> <tr> <td>4</td> <td>room temperature</td> <td>3 min max.</td> </tr> </tbody> </table>	Step	Temperature	Time	1	-40 °C ± 3 °C	40 min ± 3 min	2	room temperature	3 min max.	3	+85 °C ± 3 °C	40 min ± 3 min	4	room temperature	3 min max.
Step	Temperature	Time															
1	-40 °C ± 3 °C	40 min ± 3 min															
2	room temperature	3 min max.															
3	+85 °C ± 3 °C	40 min ± 3 min															
4	room temperature	3 min max.															
6.4.2. Load life in humidity	50 mΩ max.	Specimens shall be exposed at 60 °C ± 2 °C and 90 % to 95 % relative humidity in a humidity test chamber for 1000 h ⁺⁴⁸ ₀ h. During this time, the rated current shall be applied intermittently for 1.5 h ON, 0.5 h OFF.															
6.4.3. Endurance at 85°C	50 mΩ max.	Specimens shall be exposed at 85 °C ± 2 °C for 1000 h ⁺⁴⁸ ₀ h. During this time, the rated current shall be applied.															
6.4.4. Endurance at -40°C	50 mΩ max.	Specimens shall be exposed at -40 °C ± 2 °C for 1000 h ⁺⁴⁸ ₀ h. During this time, the rated current shall be applied.															
6.4.5. High temperature exposure	50 mΩ max.	Specimens shall be exposed at 85 °C ± 2 °C for 1000 h ⁺⁴⁸ ₀ h.															
6.4.6. Low temperature exposure	50 mΩ max.	Specimens shall be exposed at -40 °C ± 2 °C for 1000 h ⁺⁴⁸ ₀ h.															
6.4.7. Solvent resistance	No deterioration of protective coatings	Specimens shall be immersed in a bath of isopropyl alcohol completely for 5 min.															
6.4.8. Resistance to soldering heat	50 mΩ max.	Specimens shall be immersed in 260 °C ± 5 °C solder (H63A) for 10 s ± 1 s, 2 times after 150 °C ± 5 °C pre-heat for 1 min.															

Classification	Chip RF Jumper PRODUCT SPECIFICATION FOR INFORMATION		No. 151-XB-JP00BE
Subject	EXBD6JP000A		12 - 15

7. Mechanical Performance

Characteristics	Specification	Test method
7.1.1. Bond strength of the face plating	50 mΩ max. and no evidence of mechanical damage.	Specimens shall be placed on testing board that is glass-fabric based epoxy resin with 100 mm in length, 40 mm in width and 1.6 mm in thickness. The testing board shall be supported at two points 45 mm from its center with mounting surface, and middle part of its board shall be pressed at rate of 1 mm/s until the deflection becomes 1 mm and then the pressure shall be maintained for 30 s.
7.1.2. Solderability	95 % coverage min.	Specimens shall be tested by the following conditions. Test temperature of solder : 215 °C ± 5 °C Dwell time in solder : 5 s ± 0.5 s

8. Precautions for mounting

8.1. Land pattern

Land pattern is shown in the figure below.

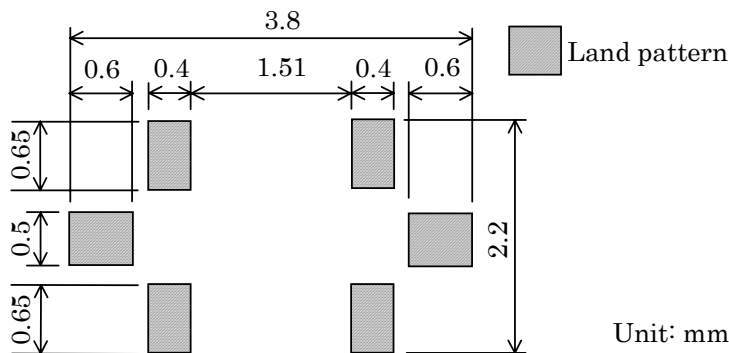

8.2. Solder cream in reflow soldering

Printing pattern of solder cream is shown in the figure below.

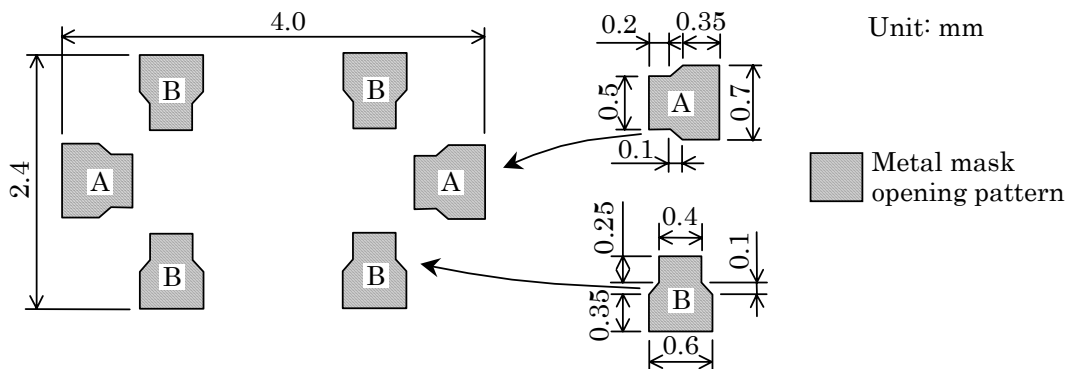

Classification Chip RF Jumper PRODUCT SPECIFICATION FOR INFORMATION	No. 151-XB-JP00BE
Subject EXBD6JP000A	12 - 16

Classification	Chip RF Jumper PRODUCT SPECIFICATION FOR INFORMATION	No. 151-XB-JP00BE
Subject	EXBD6JP000A	12 - 17

8.3. Flux

Use rosin-based flux. Do not use high-activity flux (the chlorine content is 0.2wt% or more.)

8.4. Precaution for handling of substrate

Do not bend the board after soldering the product extremely.

(Example)

- Mounting place should be as far as possible from the position which is closed to the break line of board or the line of large holes of board.
- When mounting other components, do not bend the board extremely. If necessary, use back-up pin (support pin) to prevent from bending extremely.
- Do not break the board by hand. We recommend to use the machine or the jig to break it.

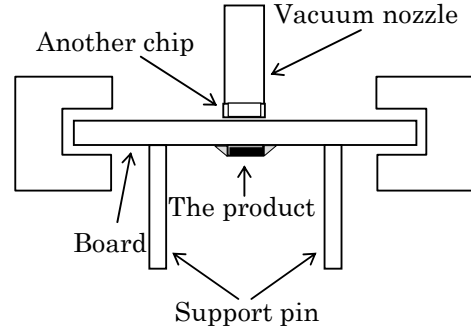

8.5. Precaution for soldering

Note that the product will be easily damaged by rapid heating, rapid cooling and local heating.

Allow enough preheating so that the difference of soldering temperature and temperature of surface of the part is 100 °C or less. This temperature difference shall be kept in rapid cooling by immersion into solvent.

8.6. Recommendable reflow soldering

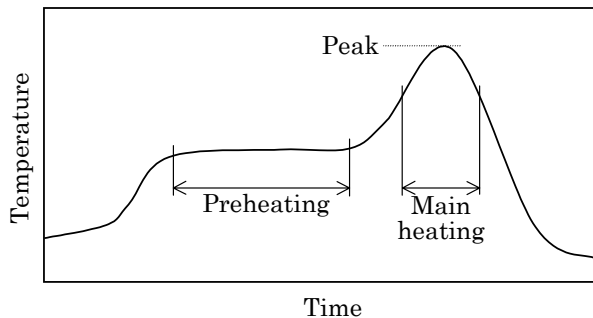

- Please measure temperature of terminals and study solderability every type of boards, before actual use.
- Please inquire of us when you use the different conditions.

<Eutectic solder> (Sn/Pb system et al.)

	Condition	Time
Preheating	140°C to 160°C	60s to 120s
Main heating	200°C min.	30s to 40s
Peak	235°C ± 5°C	10s max.

<Lead-free solder> (Sn/Ag/Cu system et al.)

	Condition	Time
Preheating	150°C to 180°C	60s to 120s
Main heating	230°C min.	30s to 40s
Peak	260°C max.	10s max.

Classification	No.
Chip RF Jumper PRODUCT SPECIFICATION FOR INFORMATION	151-XB-JP00BE
Subject	
EXBD6JP000A	12 - 18

- Reflow soldering shall be within five times.

Classification	No.
Chip RF Jumper PRODUCT SPECIFICATION FOR INFORMATION	151-XB-JP00BE
Subject	12 - 19
EXBD6JP000A	

8.7. Caution of flow soldering

We can not recommend the flow soldering to the product, because we are afraid that solder bridge may happen owing to narrow pitch of it's terminals.

8.8. Replacement with soldering iron

Note the followings in case of using soldering iron for replacement.

- (1) The tip temperature should be less than 350 °C for the period within 3 s for each terminal.
- (2) The soldering iron tip should not touch the product directly.

8.9. Recommendable cleaning method

Solvents	Isopropyl alcohol	
Cleaning method	Dipping	40 °C max., 5 min max.
	Ultrasonic	1 min max. (Power: 20 W/l max, frequency: 10 kHz to 100 kHz)

Residual fluxes after board washing may cause solder migration. Carefully check the status of board washing.

Study type and amount of flux to be used in cleaning free soldering. Study type of water-soluble flux and cleaning agent and dry condition when water washing is made.

Confirm they will not cause any troubles.

9. Notice for use

 Notice for use
<p>(1) This specification shows the quality and performance of the product in a unit component. Before adoption, be sure to evaluate and verify the product mounted on your circuit board.</p> <p>(2) Use fail-safe design and ensure safety by carrying out the following items in cases where it is forecast that the failure of the product gives serious damage to something important like human life, for instance in traffic transportation equipment (trains, cars, traffic signal equipment, etc.), medical equipment, aerospace equipment, electric heating appliances, combustion and gas equipment, rotating equipment, disaster and crime preventive equipment.</p> <ul style="list-style-type: none"> ◆ Ensure safety as the system by setting protective circuits and protective equipment. ◆ Ensure safety as the system by setting such redundant circuits as do not cause danger by a single failure. <p>(3) The product is designed to use in general standard applications of general electric equipment (AV products, household electric appliances, office equipment, information and communication equipment, etc.); hence, it do not take the use under the following special environments into consideration.</p>

Classification	No.
Chip RF Jumper PRODUCT SPECIFICATION FOR INFORMATION	151-XB-JP00BE
Subject	12 - 20
EXBD6JP000A	

 Notice for use

Accordingly, the use in the following special environments, and such environmental conditions may affect the performance of the product; prior to use, verify the performance, reliability, etc. thoroughly.

- 1) Use in liquids such as water, oil, chemical and organic solvent.
- 2) Where the product is close to a heating component, or where an inflammable such as a polyvinyl chloride wire is arranged close to the product.
- 3) Where the product is sealed or coated with resin , etc.
- 4) Where water or a water-soluble detergent is used in flux cleaning after soldering. (pay particular attention to soluble flux.)
- 5) Use in such a place where the product is wetted due to dew condensation
- 6) Use in places full of corrosive gases such as sea breeze, Cl₂, H₂S, NH₃, SO₂, and NO_x
- 7) Use under direct sunlight, in outdoor or in dusty atmospheres
- 8) Use in environment with large static electricity or strong electromagnetic waves.

(4)Whenever a doubt about safety arises from this product, please inform us immediately and be sure to evaluate and verify the product mounted on your circuit board.

10. Storage method

If the product is stored in the following environments and conditions, the performance and solderability may be badly affected. Avoid the storage in the following environments.

- (1) Storage in places full of corrosive gases such as sea breeze, Cl₂, H₂S, NH₃, SO₂, and NO_x
- (2) Storage in places exposed to direct sunlight
- (3) Storage in places outside the temperature range of 5 °C to 35 °C and humidity range of 45 %RH to 85 %RH
- (4) Storage over a year after our delivery (This item also applies to the case where the storage method specified in item (1) to (3) has been followed.)

11. Low and regulation

- (1) No ODCs or other ozone-depleting substances that are subject to regulation under the Montreal Protocol are used in our manufacturing processes, including in the manufacture of this product.
- (2) All materials used in this product are existing chemical substances recognized under "laws on examination of chemical substances and regulations of manufacturing and others."
- (3) None of the materials used in this product contain the designated incombustible bromic substances, PBBOs and PBBs.
- (4) Please contact us to obtain a notice as to whether this product has passed inspection under review criteria primarily based on Foreign Exchange and Foreign Trade Control Laws, and appended table in the Export Control Laws.

Classification	No.
Chip RF Jumper PRODUCT SPECIFICATION FOR INFORMATION	151-XB-JP00BE
Subject	12 - 21
EXBD6JP000A	

12. Period of validity for specification

If there is not an offer by 3 months before term of validity, term of validity shall be extended every one year. When you confirm revision of this specification while it is in effect, the previous, unrevised version shall lose its validity.

13. Production place

Production country: Japan

Production factory: Fukui Matsushita Electric Co., Ltd.

14. Taping package and label marking

14.1. Packaging method

Products shall be heat-sealed in the chip pockets, spacing pitch 4 mm, of paper carrier tape with bottom tape and cover tape, and the carrier tape shall be reeled to the reel.

14.2. Carrier tape dimensions

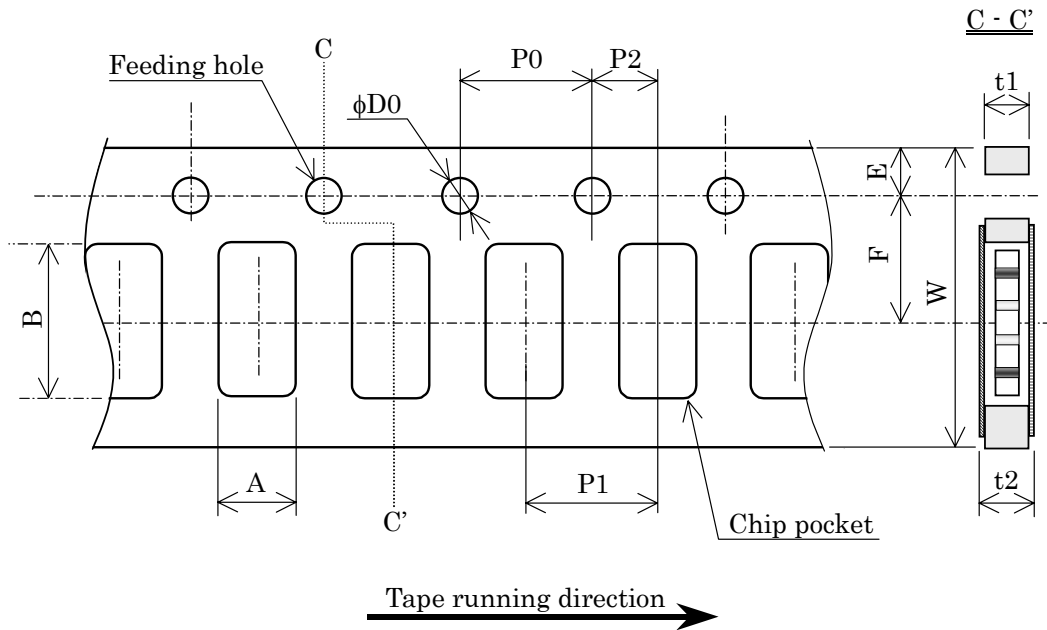

	A	B	W	F	E	P1	P2
Dimensions (mm)	2.0±0.2	3.6±0.2	8.0±0.2	3.5±0.1	1.75±0.10	4.0±0.1	2.0±0.1

	P0	$\phi D0$	t1	t2
Dimensions (mm)	4.0±0.1	1.5 ^{+0.1} _{0.0}	0.75±0.05	0.84±0.10

Classification	No.
Chip RF Jumper PRODUCT SPECIFICATION FOR INFORMATION	151-XB-JP00BE
Subject	12 - 22
EXBD6JP000A	

14.3. Taping reel dimensions and material

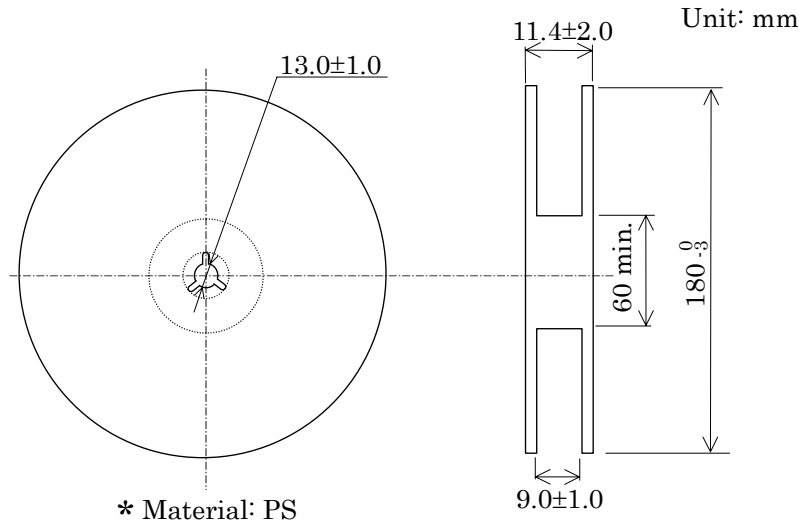

14.4. Taping specification

There shall be portions having no product in both the trailer and the leader of taping, and there shall be portion having only cover tape in the leader of taping as shown below. The component can fall headlong naturally from taping, when the cover tape was removed and the component was moved upside down.

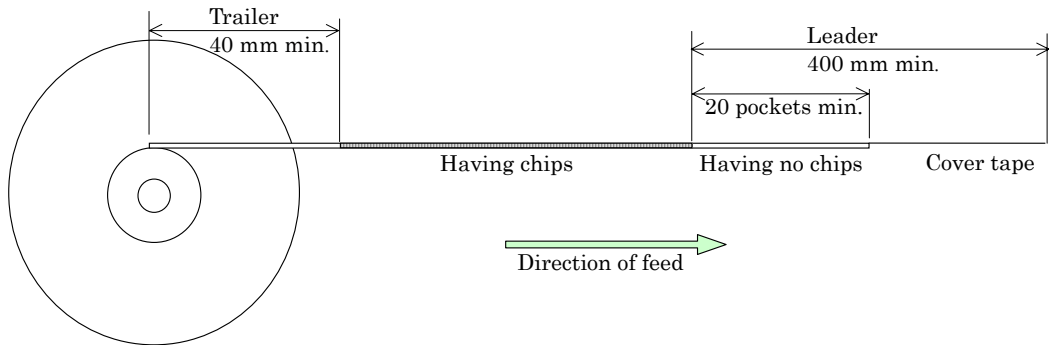

14.5. Top tape peeling strength

When the test shall be operated with the below conditions, cover tape peeling strength should be 0.1 N to 1.0 N.

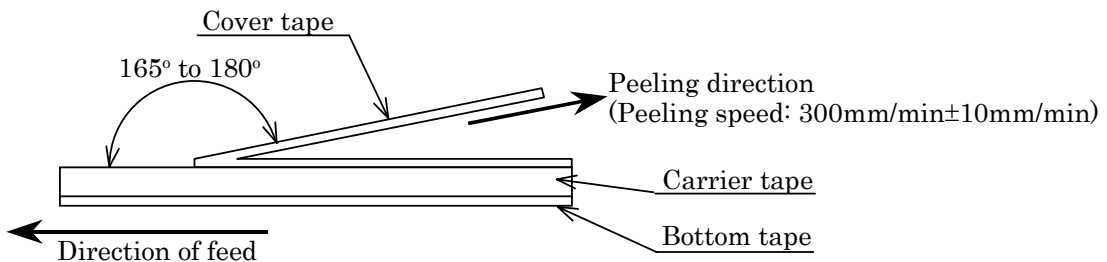

Classification	No.
Chip RF Jumper PRODUCT SPECIFICATION FOR INFORMATION	151-XB-JP00BE
Subject	12 - 23
EXBD6JP000A	

14.6. Label marking

The following items shall be indicated in the label on the reel

- (1) Part number
- (2) Quantity
- (3) Lot number or serial number

[Lot number]

2 0 4 0 4 0 0 1 0 3

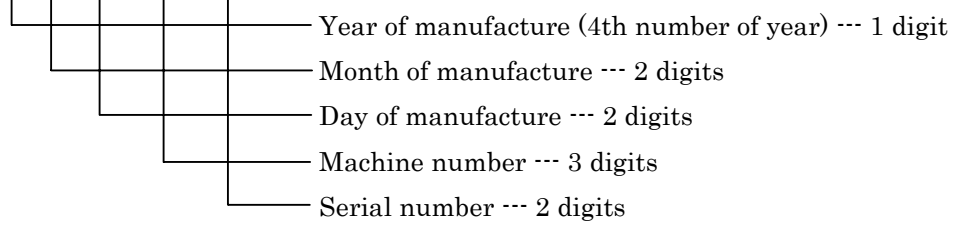

* Part number and quantity shall be indicated on outer packaging.

14.7. Quantity of products in the taping package

- (1) Standard quantity: 5,000 pcs./ reel
- (2) Shipping quantity: multiple of standard quantity.