

LOC	DIST	REVISIONS					
E	B	P	LTR	DESCRIPTION	DATE	DWN	APVD
		BA		NEW RELEASE	11-MAY-09	SM	St.P

FOR FURTHER INFORMATION SEE DATA SHEET FOR
 CRG SERIES-THICK FILM CHIP RESISTORS

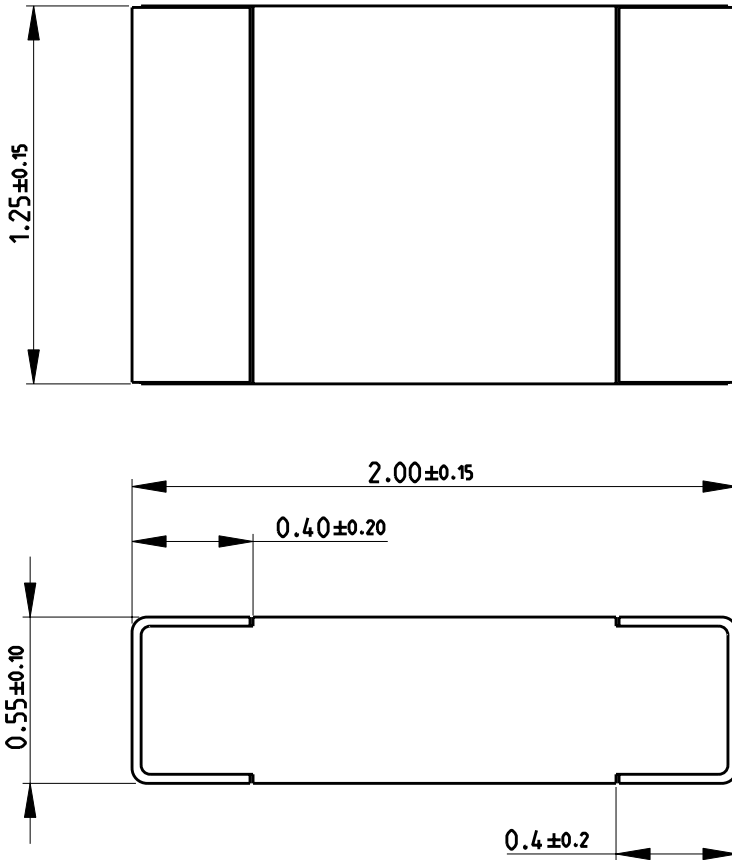

RoHS Compliant

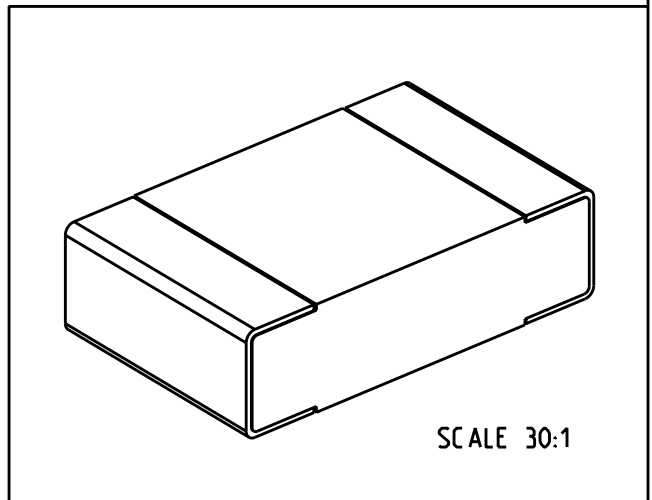

2009

RELEASED FOR PUBLICATION

THIS DRAWING IS UNPUBLISHED.

BY TYCO ELECTRONICS CORPORATION. ALL RIGHTS RESERVED.

© COPYRIGHT 2009

DIMENSIONS:		DWN	11-MAY-09	MATERIAL	-	FINISH	-
mm		SUBHASH.M		Tyco Electronics Corporation Dorcan, Swindon, SN3 5HH			
TOLERANCES UNLESS OTHERWISE SPECIFIED:		CHK	11-MAY-09				
0 PLC ± 0.5		PRAKASH.S					
1 PLC ± 0.2		APVD	11-MAY-09	NAME			
2 PLC ± 0.1		STEPHEN.P		THICK FILM CHIP RESISTORS			
3 PLC ± -		PRODUCT SPEC	-	SERIES CRG 0805			
4 PLC ± -		APPLICATION SPEC	-	SIZE	CAGE CODE	DRAWING NO	RESTRICTED TO
ANGLES ± 5°		WEIGHT	-	A 4	00779	C- 1623243	-
CUSTOMER DRAWING				SCALE	40:1	SHEET	1 OF 1
				REV			
				BA			