

CPDF5V0C-HF

RoHS Device
Halogen Free

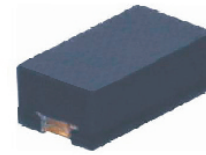

Features

- Bi-directional ESD protection.
- Surface mount package.
- Operating voltage: 5V.

Mechanical data

- Case: 1005/SOD-323F standard package, molded plastic.
- Terminals: Gold plated, solderable per MIL-STD-750, method 2026.
- Marking Code:
CPDF5V0C-HF: E05
- Mounting position: Any.
- Weight: 0.006 grams (approx.).

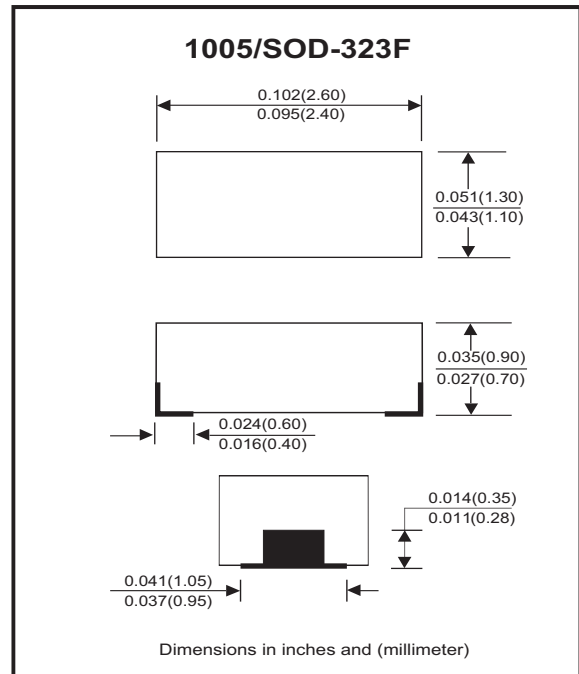

Circuit diagram



Electrical Characteristics (at TA=25°C unless otherwise noted)

Parameter	Conditions	Symbol	Min	Typ	Max	Unit
Diode breakdown voltage	IR = 1mA	V _{BD}	6.1	7.0		V
Leakage current	VR = 5V	I _L		0.1	2.0	uA
Junction capacitance	VR = 0V, f = 1MHz	C _T		25	30	pF
ESD capability	IEC 61000-4-2(air)	ESD			16	kV
	IEC 61000-4-2(contact)				8	
Clamping Voltage	I _{PP} = 1 A, tp=8/20us	V _c			10	V
	I _{PP} = 4 A, tp=8/20us	V _c			17	V
Peak Pulse Power	TP=8/20us	P _{PP}			58	W
Operation temperature range		T _j	-55		125	°C
Storage temperature range		T _{STG}	-55		150	°C

RATING AND CHARACTERISTIC CURVES (CPDF5V0C-HF)

Fig.1 - Reverse Characteristics

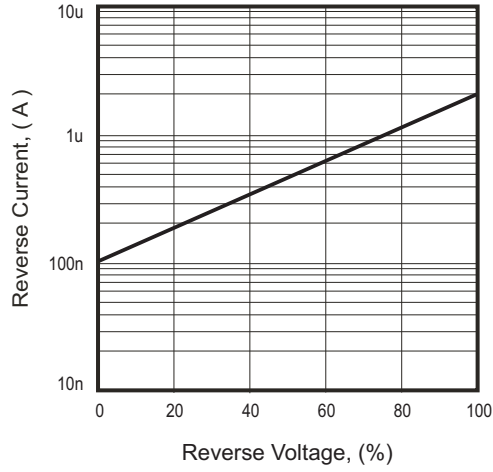

Fig.2 - Capacitance Between Terminals Characteristics

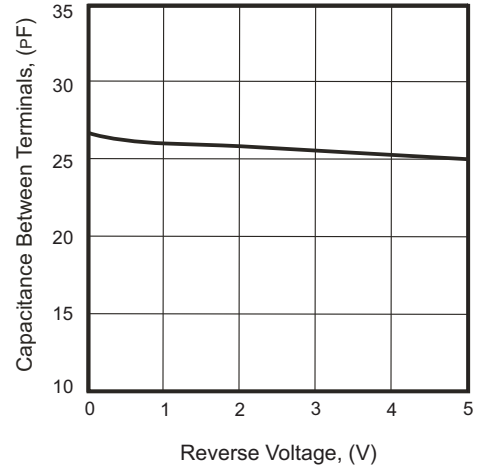

Fig.3 - Clamping Voltage Vs. Peak Pulse Current

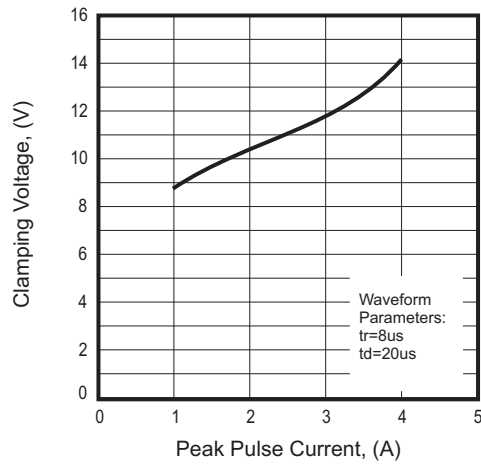
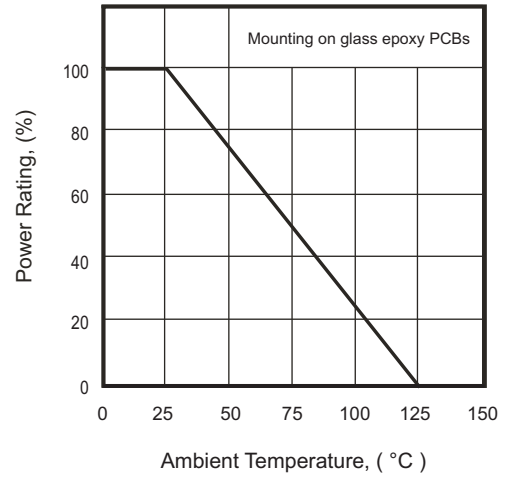
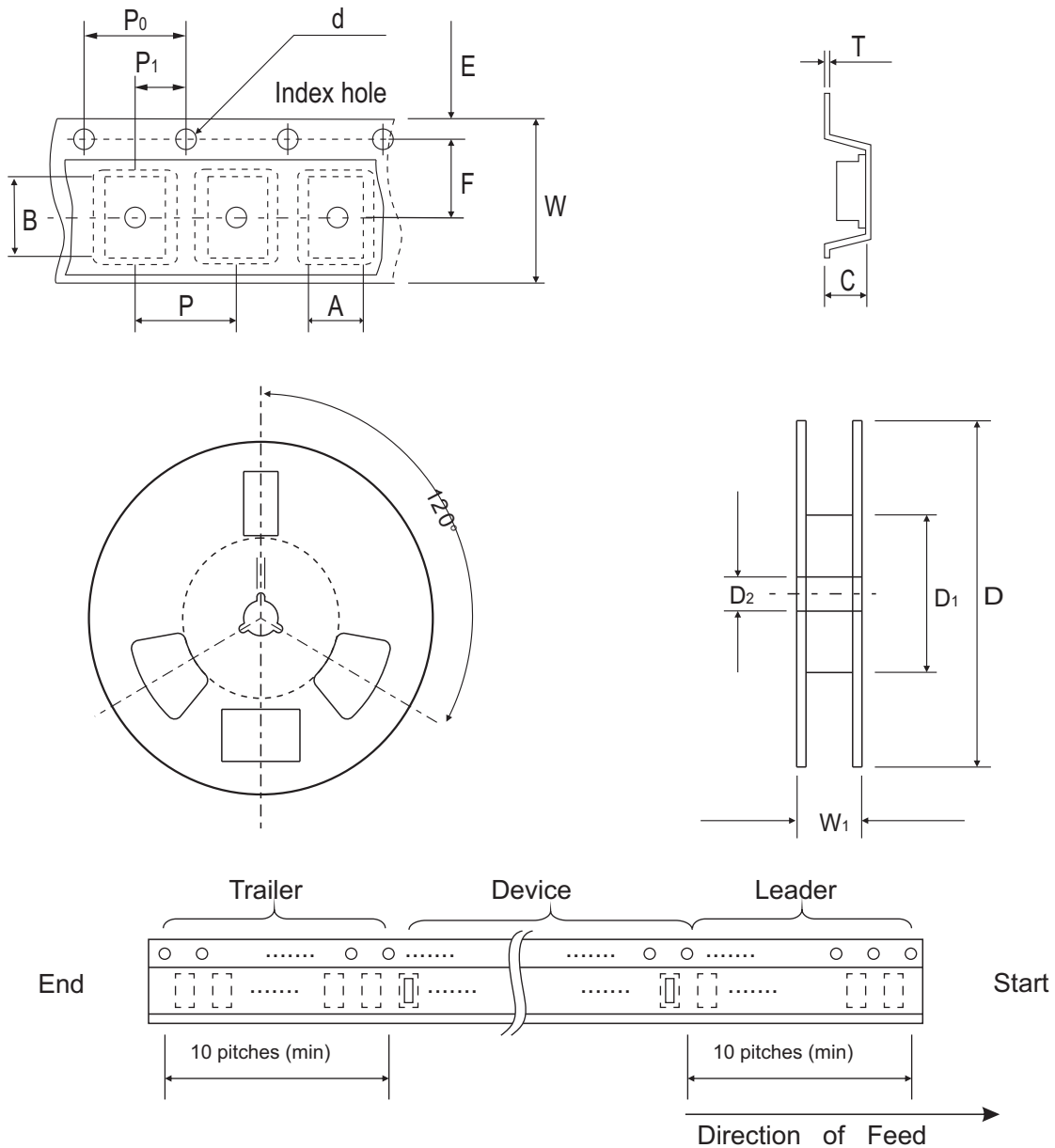

Fig.4 - Power Rating Derating Curve



Reel Taping Specification



1005 (SOD-323F)	SYMBOL	A	B	C	d	D	D ₁	D ₂
	(mm)	1.55 ± 0.10	2.65 ± 0.10	1.05 ± 0.10	1.55 ± 0.05	178 ± 1.0	60.0 MIN.	13.00 ± 0.20
	(inch)	0.061 ± 0.004	0.104 ± 0.004	0.041 ± 0.004	0.061 ± 0.002	7.008 ± 0.04	2.362 MIN.	0.512 ± 0.008

1005 (SOD-323F)	SYMBOL	E	F	P	P ₀	P ₁	T	W	W ₁
	(mm)	1.75 ± 0.10	3.50 ± 0.05	4.00 ± 0.10	4.00 ± 0.10	2.00 ± 0.05	0.23 ± 0.05	8.00 ± 0.20	13.5 MAX.
	(inch)	0.069 ± 0.004	0.138 ± 0.002	0.157 ± 0.004	0.157 ± 0.004	0.079 ± 0.002	0.009 ± 0.002	0.315 ± 0.008	0.531 MAX.

Company reserves the right to improve product design, functions and reliability without notice.

REV:B

Marking Code

Part Number	Marking Code
CPDF5V0C-HF	E05



Suggested PAD Layout

SIZE	1005/SOD-323F	
	(mm)	(inch)
A	2.10	0.083
B	1.20	0.047
C	1.20	0.047
D	3.30	0.130
E	0.90	0.035

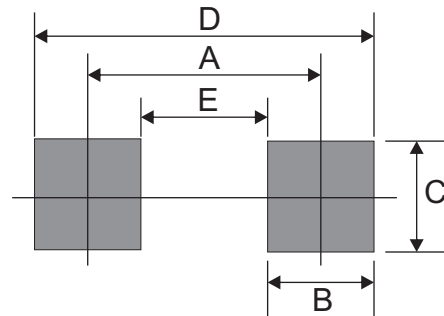

Standard Packaging

Case Type	Qty Per Reel	Reel Size
	(Pcs)	(inch)
1005/SOD-323F	4,000	7