

High Voltage IGBT

IXGF32N170

(Electrically Isolated Tab)

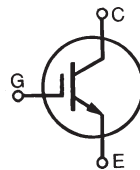

$V_{CES} = 1700V$
 $I_{C110} = 19A$
 $V_{CE(sat)} \leq 3.5V$
 $t_{fi(typ)} = 250ns$

ISOPLUS i4-Pak™

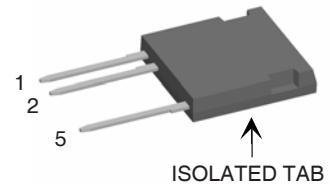

1 = Gate
2 = Emitter
5 = Collector

Symbol	Test Conditions	Maximum Ratings	
V_{CES}	$T_J = 25^\circ C$ to $150^\circ C$	1700	V
V_{GES}	Continuous	± 20	V
V_{GEM}	Transient	± 30	V
I_{C25}	$T_C = 25^\circ C$	44	A
I_{C110}	$T_C = 110^\circ C$	19	A
I_{CM}	$T_C = 25^\circ C$, 1ms	200	A
SSOA	$V_{GE} = 15V$, $T_{VJ} = 125^\circ C$, $R_G = 2.7\Omega$	$I_{CM} = 70$	A
(RBSOA)	Clamped Inductive Load	@ $0.8 \cdot V_{CES}$	
t_{sc}	$T_C = 125^\circ C$, $V_{CE} = 1200V$, $V_{GE} = 15V$, $R_G = 10\Omega$	10	μs
P_C	$T_C = 25^\circ C$	200	W
T_J		-55 ... +150	$^\circ C$
T_{JM}		150	$^\circ C$
T_{stg}		-55 ... +150	$^\circ C$
T_L	1.6 mm (0.062 in.) from Case for 10s	300	$^\circ C$
T_{SOLD}	Plastic Body for 10s	260	$^\circ C$
F_C	Mounting Force	20..120 / 4.5..27	Nm/lb.in.
V_{ISOL}	50/60Hz, 1 minute	2500	V~
Weight		5	g

Features

- Electrically Isolated Tab
- High Current Handling Capability
- Rugged NPT Structure
- Molding Epoxies Meet UL 94 V-0 Flammability Classification

Applications

- Capacitor Discharge & Pulser Circuits
- AC Motor Drives
- Uninterruptible Power Supplies (UPS)
- Switched-Mode and Resonant-Mode Power Supplies

Advantages

- High Power Density
- Suitable for Surface Mounting

Symbol	Test Conditions ($T_J = 25^\circ C$, Unless Otherwise Specified)	Characteristic Values		
		Min.	Typ.	Max.
BV_{CES}	$I_C = 1mA$, $V_{GE} = 0V$	1700		V
$V_{GE(th)}$	$I_C = 250\mu A$, $V_{CE} = V_{GE}$	3.0		5.0 V
I_{CES}	$V_{CE} = 0.8 \cdot V_{CES}$, $V_{GE} = 0V$, Note 2 $T_J = 125^\circ C$			50 μA 1 mA
I_{GES}	$V_{CE} = 0V$, $V_{GE} = \pm 20V$			± 100 nA
$V_{CE(sat)}$	$I_C = 32A$, $V_{GE} = 15V$, Note 1 $T_J = 125^\circ C$	2.7 3.3	3.5	V V

Symbol	Test Conditions ($T_J = 25^\circ\text{C}$, Unless Otherwise Specified)	Characteristic Values		
		Min.	Typ.	Max.
g_{fs}	$I_C = 32\text{A}$, $V_{CE} = 10\text{V}$, Note 1	20	30	S
C_{ies}	$V_{CE} = 25\text{V}$, $V_{GE} = 0\text{V}$, $f = 1\text{MHz}$		4290	pF
C_{oes}			167	pF
C_{res}			47	pF
Q_g	$I_C = 32\text{A}$, $V_{GE} = 15\text{V}$, $V_{CE} = 0.5 \cdot V_{CES}$		146	nC
Q_{ge}			28	nC
Q_{gc}			52	nC
$t_{d(on)}$	Inductive load, $T_J = 25^\circ\text{C}$ $I_C = 32\text{A}$, $V_{GE} = 15\text{V}$ $V_{CE} = 0.6 \cdot V_{CES}$, $R_G = 2.7\Omega$		45	ns
t_{ri}			38	ns
$t_{d(off)}$			270	500 ns
t_{fi}			250	500 ns
E_{off}			10.6	20 mJ
$t_{d(on)}$	Inductive load, $T_J = 125^\circ\text{C}$ $I_C = 32\text{A}$, $V_{GE} = 15\text{V}$ $V_{CE} = 0.6 \cdot V_{CES}$, $R_G = 2.7\Omega$		48	ns
t_{ri}			42	ns
E_{off}			6.0	mJ
$t_{d(off)}$			360	ns
t_{fi}			560	ns
E_{off}		13.5	mJ	
R_{thJC}			0.62	$^\circ\text{C/W}$
R_{thCS}		0.15		$^\circ\text{C/W}$
R_{thJA}		30		$^\circ\text{C/W}$

ISOPLUS i4-Pak™ (HV) (IXGF) Outline

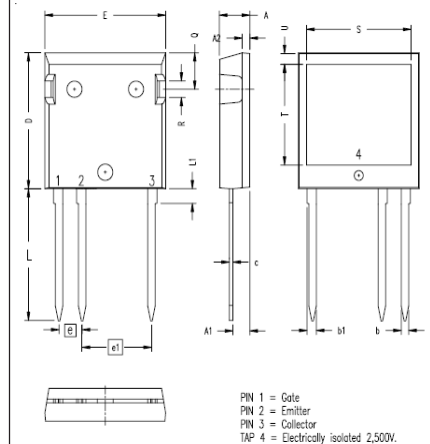

SYM	INCHES		MILLIMETERS	
	MIN	MAX	MIN	MAX
A	.190	.205	4.83	5.21
A1	.102	.118	2.59	3.00
A2	.046	.085	1.17	2.16
b	.045	.055	1.14	1.40
b1	.058	.068	1.47	1.73
C	.020	.029	0.51	0.74
D	.819	.840	20.80	21.34
E	.770	.799	19.56	20.29
e	.150 BSC		3.81 BSC	
e1	.450 BSC		11.43 BSC	
L	.780	.840	19.81	21.34
L1	.083	.102	2.11	2.59
Q	.210	.244	5.33	6.20
R	.100	.180	2.54	4.57
S	.660	.690	16.76	17.53
T	.590	.620	14.99	15.75
U	.065	.080	1.65	2.03

- Notes: 1. Pulse test, $t < 300\mu\text{s}$; duty cycle, $d < 2\%$.
2. Device must be heatsunk for high temperature leakage current measurements to avoid thermal runaway.

IXYS Reserves the Right to Change Limits, Test Conditions, and Dimensions.

IXYS MOSFETs and IGBTs are covered by one or more of the following U.S. patents:	4,835,592	4,931,844	5,049,961	5,237,481	6,162,665	6,404,065 B1	6,683,344	6,727,585	7,005,734 B2	7,157,338B2
	4,850,072	5,017,508	5,063,307	5,381,025	6,259,123 B1	6,534,343	6,710,405 B2	6,759,692	7,063,975 B2	
	4,881,106	5,034,796	5,187,117	5,486,715	6,306,728 B1	6,583,505	6,710,463	6,771,478 B2	7,071,537	

Fig. 1. Output Characteristics @ 25°C

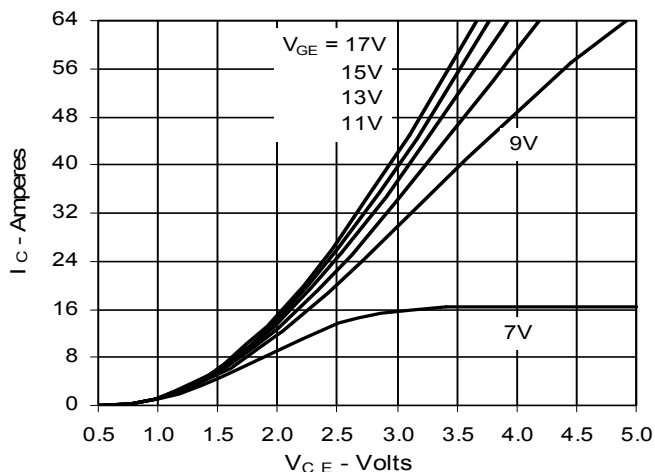

Fig. 2. Extended Output Characteristics @ 25°C

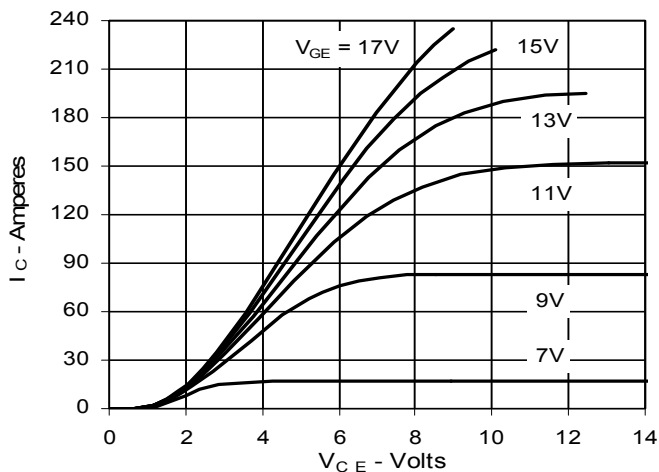

Fig. 3. Output Characteristics @ 125°C

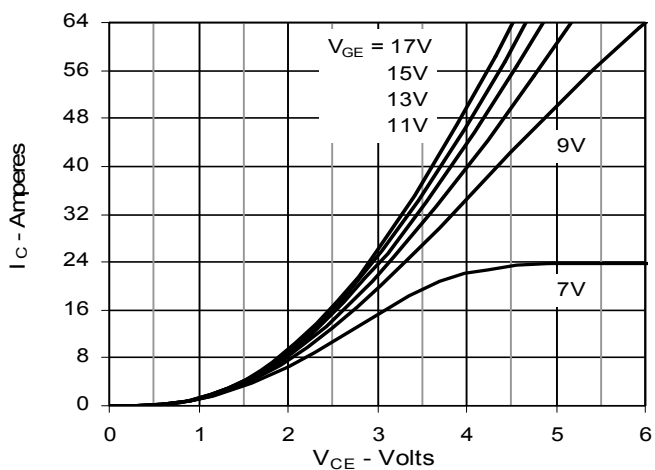

Fig. 4. Dependence of $V_{CE(sat)}$ on Temperature

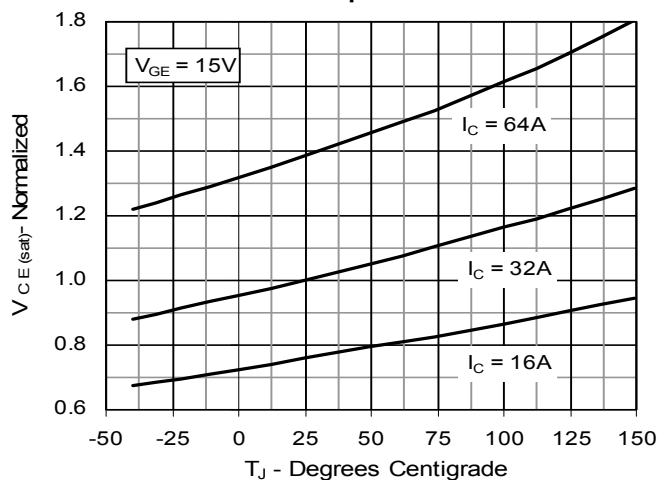

Fig. 5. Collector-to-Emitter Voltage vs. Gate-to-Emitter voltage

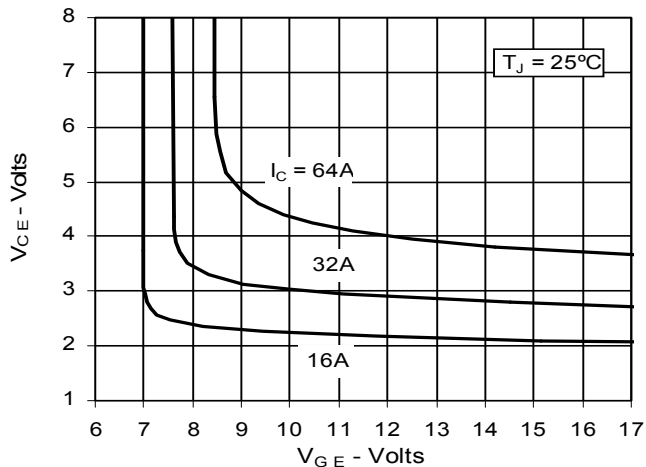

Fig. 6. Input Admittance

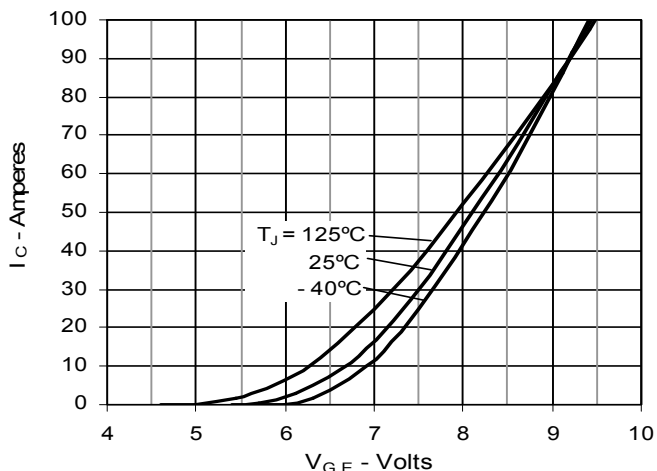

Fig. 7. Transconductance

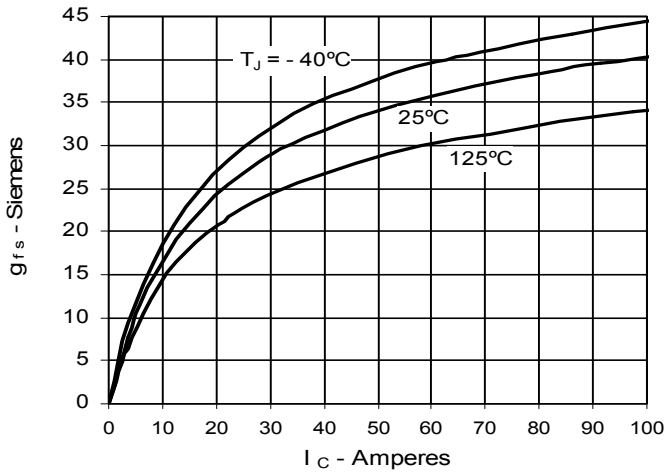

Fig. 8. Gate Charge

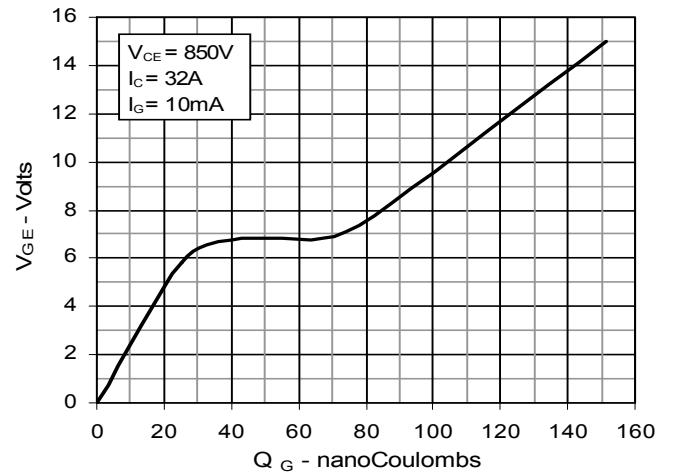

Fig. 9. Capacitance

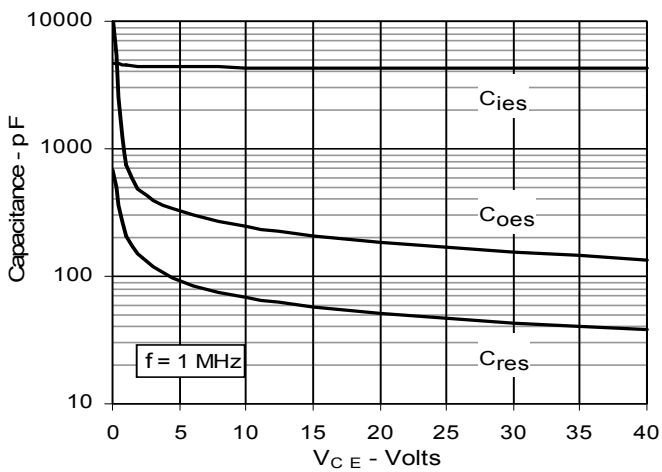

Fig. 10. Dependence of E_{off} on R_G

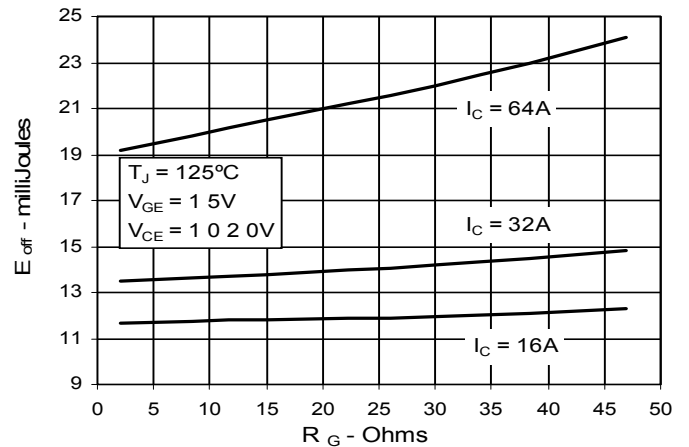

Fig. 11. Dependence of E_{off} on I_C

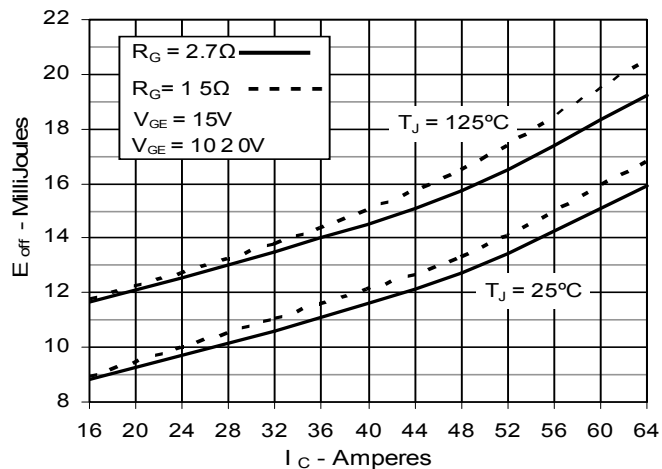

Fig. 12. Dependence of E_{off} on Temperature

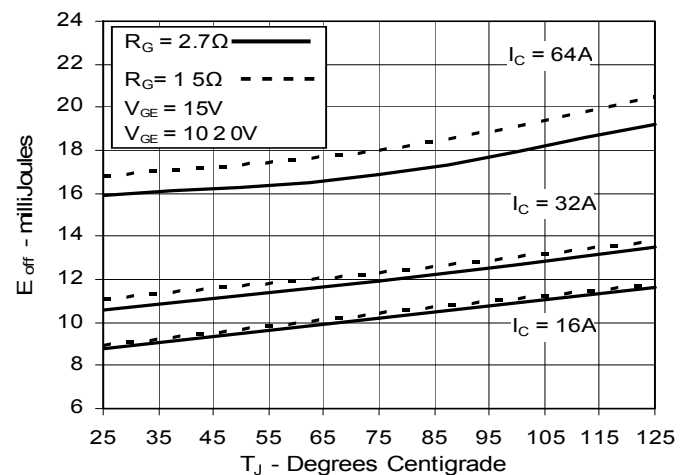

Fig. 13. Maximum Transient Thermal Impedance

