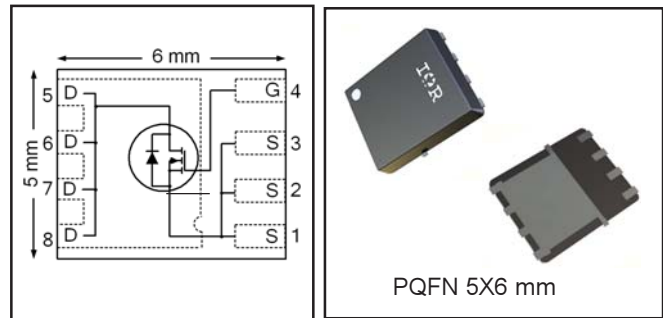


HEXFET® Power MOSFET

$V_{DS}$	<b>30</b>	<b>V</b>
$V_{GS\ max}$	<b>± 20</b>	<b>V</b>
$R_{DS(on)\ max}$ (@ $V_{GS} = 10V$ )	<b>2.95</b>	<b>mΩ</b>
(@ $V_{GS} = 4.5V$ )	<b>4.30</b>	
$Q_g\ typ$	<b>30.0</b>	<b>nC</b>
$I_D$ (@ $T_{c(Bottom)} = 25°C$ )	<b>50</b> ⑦	<b>A</b>



**Applications**

- Synchronous MOSFET for high frequency buck converters

**Features and Benefits**

**Features**

Low Thermal Resistance to PCB (< 1.7°C/W)
Low Profile (< 1.2mm)
Industry-Standard Pinout
Compatible with Existing Surface Mount Techniques
RoHS Compliant Containing no Lead, no Bromide and no Halogen
MSL1, Consumer Qualification

results in  
⇒

**Benefits**

Enable better thermal dissipation
Increased Power Density
Multi-Vendor Compatibility
Easier Manufacturing
Environmentally Friendlier
Increased Reliability

Orderable part number	Package Type	Standard Pack		Note
		Form	Quantity	
IRFH8316TRPBF	PQFN 5mm x 6mm	Tape and Reel	4000	
IRFH8316TR2PBF	PQFN 5mm x 6mm	Tape and Reel	400	

**Absolute Maximum Ratings**

	Parameter	Max.	Units
$V_{DS}$	Drain-to-Source Voltage	30	V
$V_{GS}$	Gate-to-Source Voltage	± 20	
$I_D @ T_A = 25°C$	Continuous Drain Current, $V_{GS} @ 10V$	27	A
$I_D @ T_A = 70°C$	Continuous Drain Current, $V_{GS} @ 10V$	21	
$I_D @ T_{c(Bottom)} = 25°C$	Continuous Drain Current, $V_{GS} @ 10V$	120⑥⑦	
$I_D @ T_{c(Bottom)} = 100°C$	Continuous Drain Current, $V_{GS} @ 10V$	78⑥⑦	
$I_D @ T_C = 25°C$	Continuous Drain Current, $V_{GS} @ 10V$ (Package Limited)	50⑦	
$I_{DM}$	Pulsed Drain Current ①	490	
$P_D @ T_A = 25°C$	Power Dissipation ②	3.6	W
$P_D @ T_{c(Bottom)} = 25°C$	Power Dissipation ②	59	
	Linear Derating Factor ③	0.029	W/°C
$T_J$	Operating Junction and	-55 to + 150	°C
$T_{STG}$	Storage Temperature Range		

Notes ① through ⑦ are on page 9

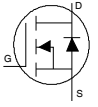
**Static @ T<sub>J</sub> = 25°C (unless otherwise specified)**

	Parameter	Min.	Typ.	Max.	Units	Conditions
BV <sub>DSS</sub>	Drain-to-Source Breakdown Voltage	30	—	—	V	V <sub>GS</sub> = 0V, I <sub>D</sub> = 250μA
ΔBV <sub>DSS</sub> /ΔT <sub>J</sub>	Breakdown Voltage Temp. Coefficient	—	21	—	mV/°C	Reference to 25°C, I <sub>D</sub> = 1.0mA
R <sub>DS(on)</sub>	Static Drain-to-Source On-Resistance	—	2.40	2.95	mΩ	V <sub>GS</sub> = 10V, I <sub>D</sub> = 20A ③
		—	3.40	4.30		V <sub>GS</sub> = 4.5V, I <sub>D</sub> = 16A ③
V <sub>GS(th)</sub>	Gate Threshold Voltage	1.2	1.7	2.2	V	V <sub>DS</sub> = V <sub>GS</sub> , I <sub>D</sub> = 50μA
ΔV <sub>GS(th)</sub>	Gate Threshold Voltage Coefficient	—	-6.4	—	mV/°C	
I <sub>DSS</sub>	Drain-to-Source Leakage Current	—	—	1	μA	V <sub>DS</sub> = 24V, V <sub>GS</sub> = 0V
		—	—	150		V <sub>DS</sub> = 24V, V <sub>GS</sub> = 0V, T <sub>J</sub> = 125°C
I <sub>GSS</sub>	Gate-to-Source Forward Leakage	—	—	100	nA	V <sub>GS</sub> = 20V
	Gate-to-Source Reverse Leakage	—	—	-100		V <sub>GS</sub> = -20V
g <sub>fs</sub>	Forward Transconductance	69	—	—	S	V <sub>DS</sub> = 10V, I <sub>D</sub> = 20A
Q <sub>g</sub>	Total Gate Charge	—	59	—	nC	V <sub>GS</sub> = 10V, V <sub>DS</sub> = 15V, I <sub>D</sub> = 20A
Q <sub>g</sub>	Total Gate Charge	—	30.0	45.0	nC	V <sub>DS</sub> = 15V V <sub>GS</sub> = 4.5V I <sub>D</sub> = 20A
Q <sub>gs1</sub>	Pre-V <sub>th</sub> Gate-to-Source Charge	—	7.0	—		
Q <sub>gs2</sub>	Post-V <sub>th</sub> Gate-to-Source Charge	—	2.7	—		
Q <sub>gd</sub>	Gate-to-Drain Charge	—	9.7	—		
Q <sub>godr</sub>	Gate Charge Overdrive	—	10.6	—		
Q <sub>sw</sub>	Switch Charge (Q <sub>gs2</sub> + Q <sub>gd</sub> )	—	12.4	—		
Q <sub>oss</sub>	Output Charge	—	18	—	nC	V <sub>DS</sub> = 16V, V <sub>GS</sub> = 0V
R <sub>G</sub>	Gate Resistance	—	1.1	1.7	Ω	
t <sub>d(on)</sub>	Turn-On Delay Time	—	19	—	ns	V <sub>DD</sub> = 15V, V <sub>GS</sub> = 4.5V I <sub>D</sub> = 20A R <sub>G</sub> = 1.8Ω
t <sub>r</sub>	Rise Time	—	67	—		
t <sub>d(off)</sub>	Turn-Off Delay Time	—	20	—		
t <sub>f</sub>	Fall Time	—	24	—		
C <sub>iss</sub>	Input Capacitance	—	3610	—	pF	V <sub>GS</sub> = 0V V <sub>DS</sub> = 10V f = 1.0MHz
C <sub>oss</sub>	Output Capacitance	—	740	—		
C <sub>rss</sub>	Reverse Transfer Capacitance	—	390	—		

**Avalanche Characteristics**

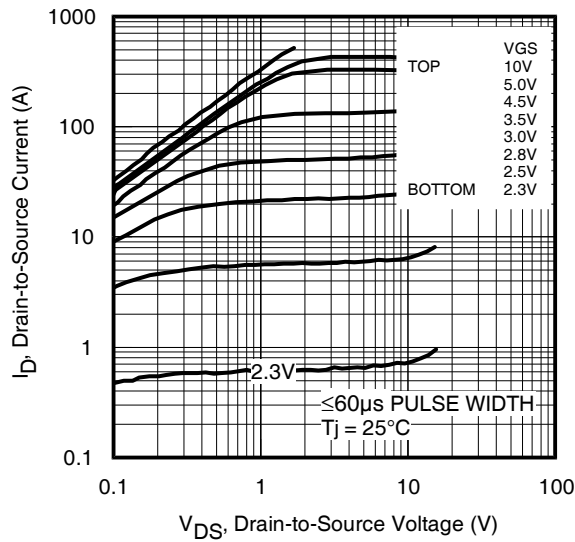
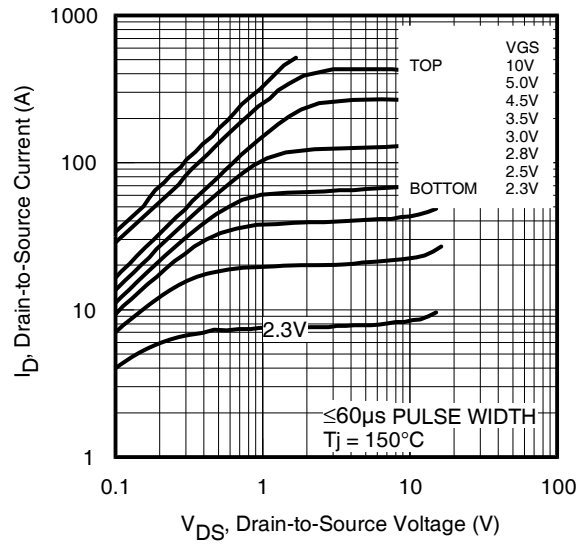
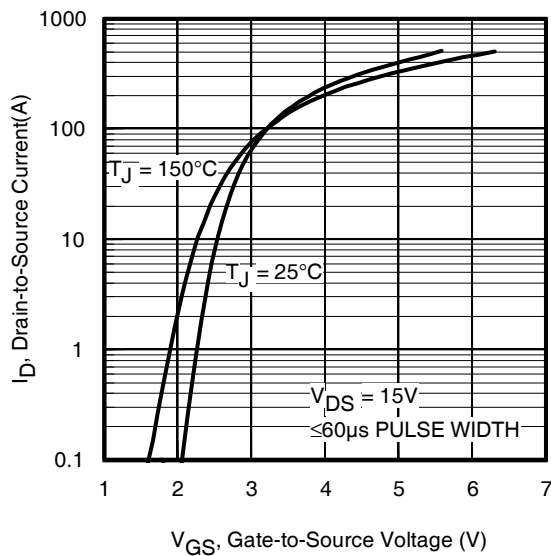
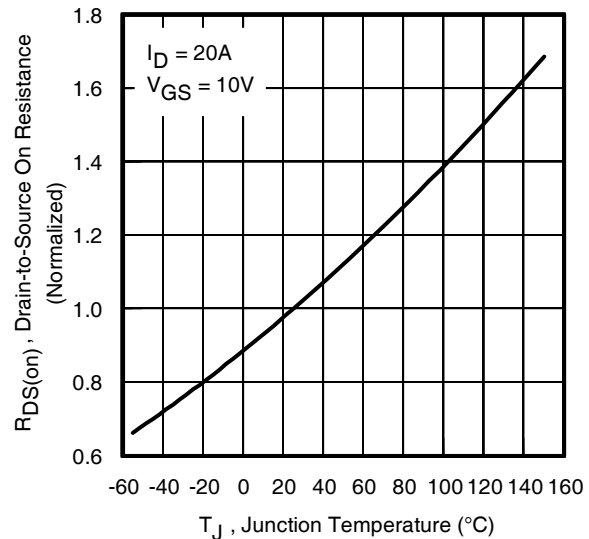
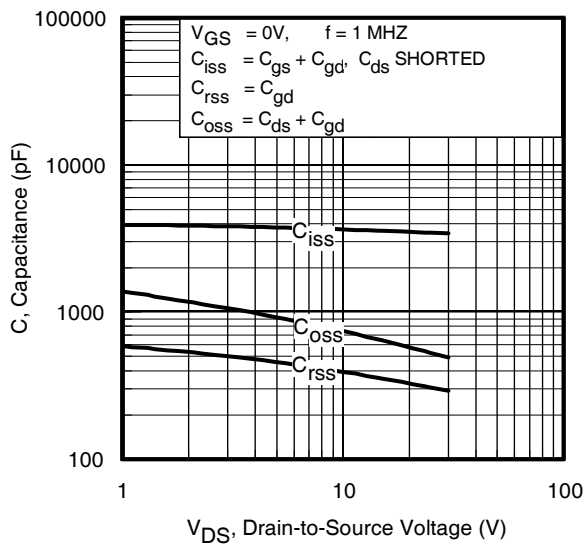
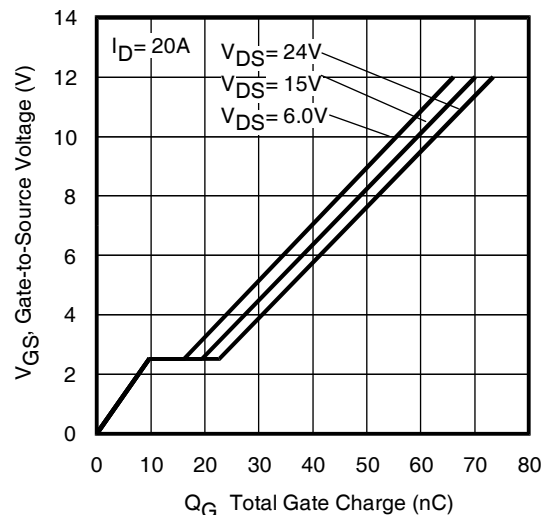
	Parameter	Typ.	Max.	Units
E <sub>AS</sub>	Single Pulse Avalanche Energy ②	—	160	mJ
I <sub>AR</sub>	Avalanche Current ①	—	20	A

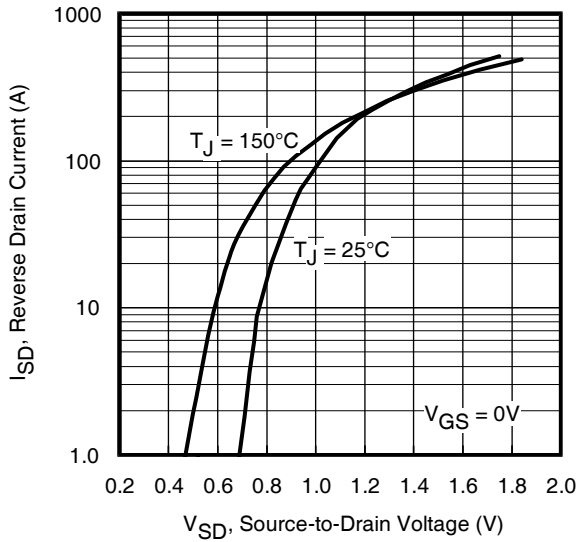
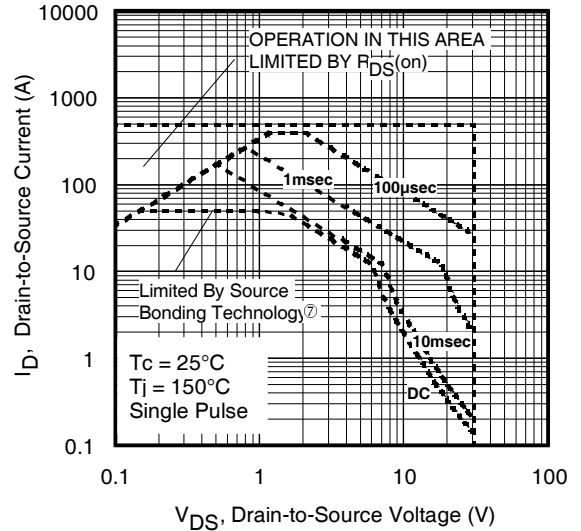
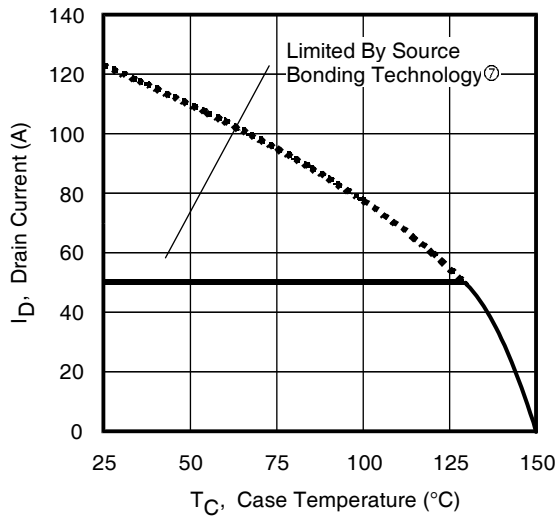
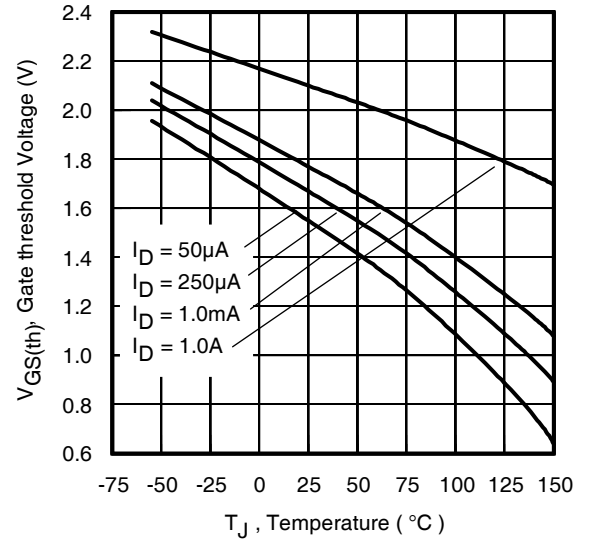
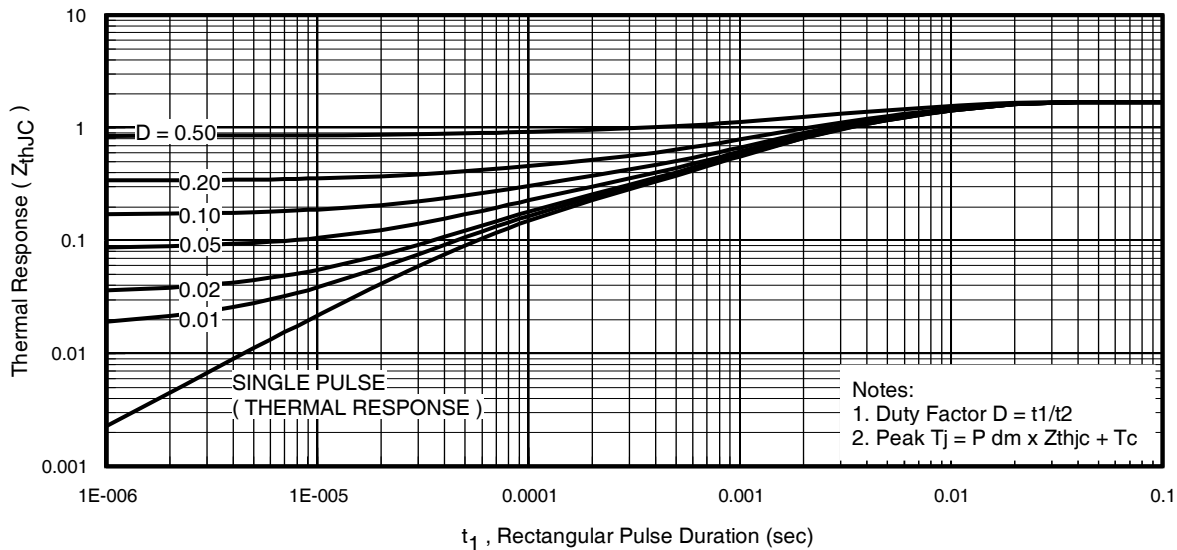
**Diode Characteristics**

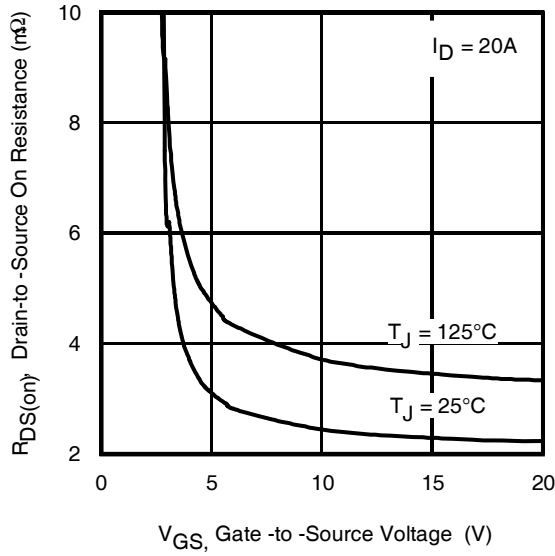
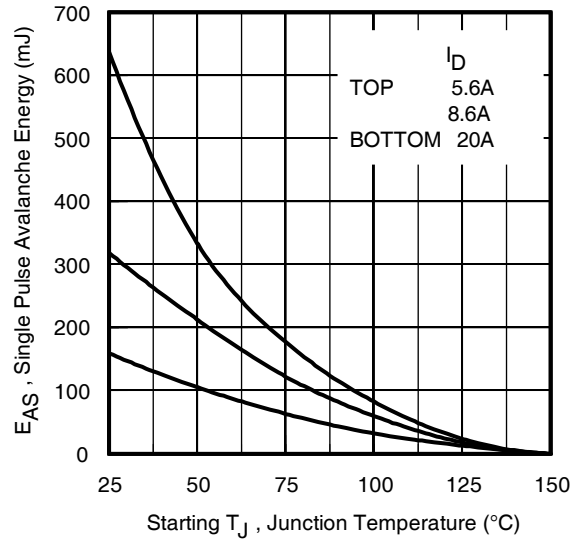
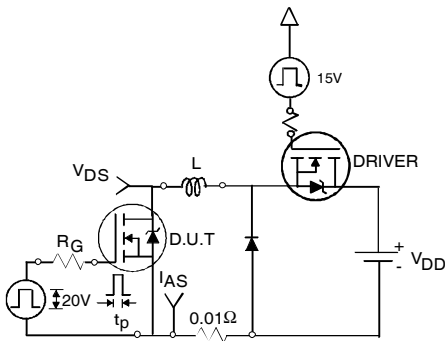
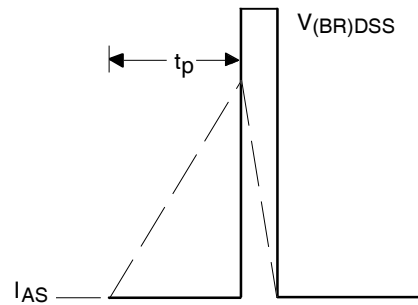
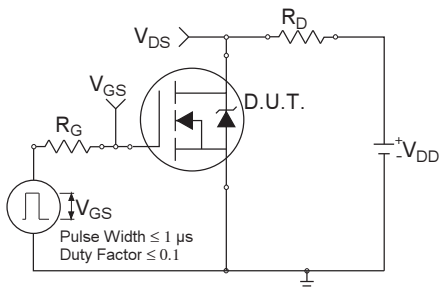
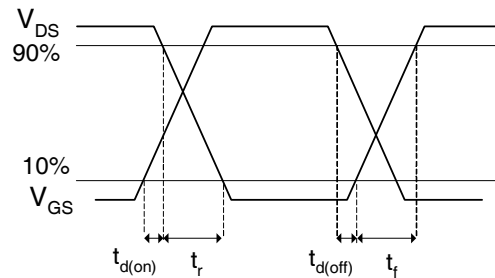
	Parameter	Min.	Typ.	Max.	Units	Conditions
I <sub>S</sub>	Continuous Source Current (Body Diode)	—	—	50 ②	A	MOSFET symbol showing the integral reverse p-n junction diode. 
I <sub>SM</sub>	Pulsed Source Current (Body Diode) ①	—	—	490		
V <sub>SD</sub>	Diode Forward Voltage	—	—	1.0	V	T <sub>J</sub> = 25°C, I <sub>S</sub> = 20A, V <sub>GS</sub> = 0V ③
t <sub>rr</sub>	Reverse Recovery Time	—	14	21	ns	T <sub>J</sub> = 25°C, I <sub>F</sub> = 20A, V <sub>DD</sub> = 15V
Q <sub>rr</sub>	Reverse Recovery Charge	—	18	27	nC	di/dt = 380A/μs ③
t <sub>on</sub>	Forward Turn-On Time	Time is dominated by parasitic Inductance				

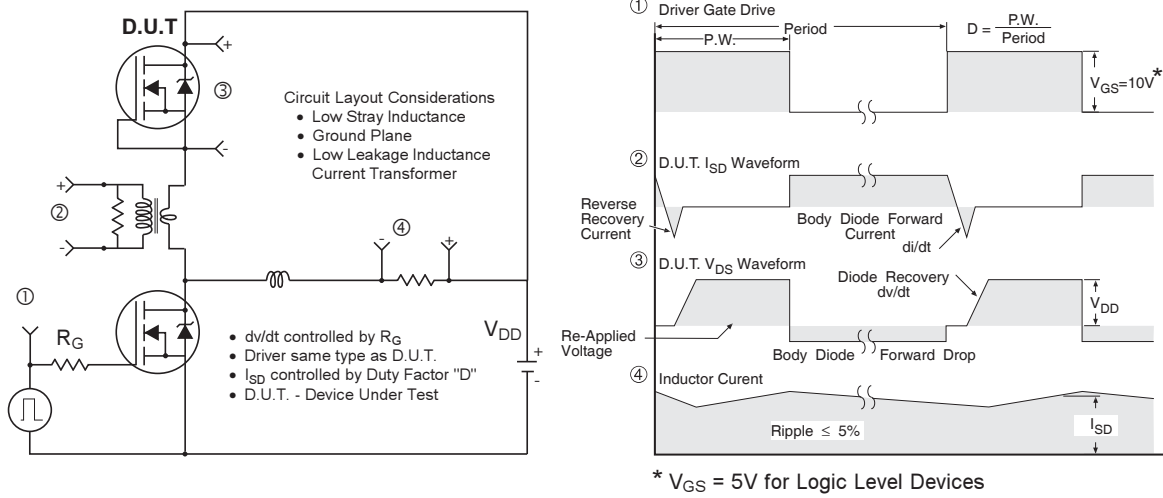
**Thermal Resistance**

	Parameter	Typ.	Max.	Units
R <sub>θJC</sub> (Bottom)	Junction-to-Case ④	—	1.7	°C/W
R <sub>θJC</sub> (Top)	Junction-to-Case ④	—	32	
R <sub>θJA</sub>	Junction-to-Ambient ⑤	—	35	
R <sub>θJA</sub> (<10s)	Junction-to-Ambient ⑤	—	22	

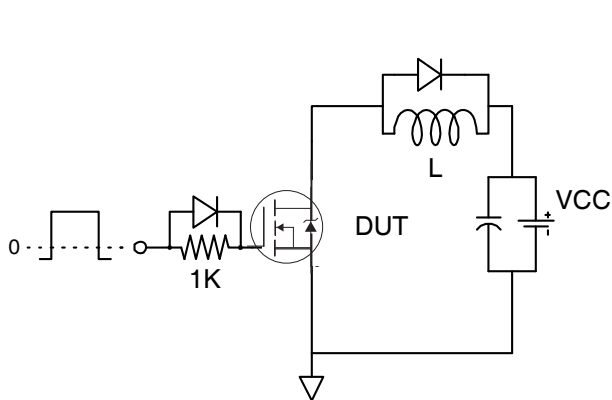

**Fig 1. Typical Output Characteristics**

**Fig 2. Typical Output Characteristics**

**Fig 3. Typical Transfer Characteristics**

**Fig 4. Normalized On-Resistance vs. Temperature**

**Fig 5. Typical Capacitance vs. Drain-to-Source Voltage**

**Fig 6. Typical Gate Charge vs. Gate-to-Source Voltage**


**Fig 7.** Typical Source-Drain Diode Forward Voltage

**Fig 8.** Maximum Safe Operating Area

**Fig 9.** Maximum Drain Current vs. Case (Bottom) Temperature

**Fig 10.** Threshold Voltage vs. Temperature

**Fig 11.** Maximum Effective Transient Thermal Impedance, Junction-to-Case (Bottom)

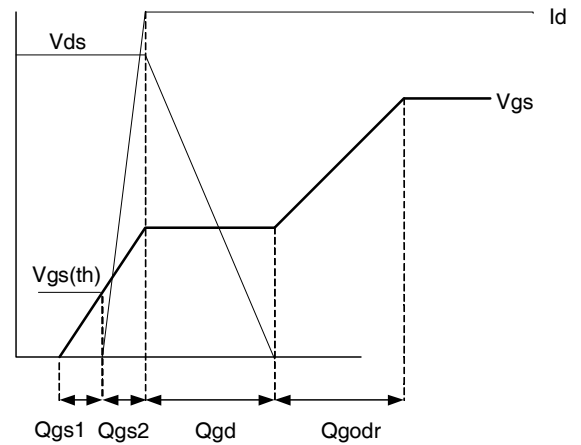

**Fig 12. On-Resistance vs. Gate Voltage**

**Fig 13. Maximum Avalanche Energy vs. Drain Current**

**Fig 14a. Unclamped Inductive Test Circuit**

**Fig 14b. Unclamped Inductive Waveforms**

**Fig 15a. Switching Time Test Circuit**

**Fig 15b. Switching Time Waveforms**



**Fig 16. Peak Diode Recovery  $dv/dt$  Test Circuit for N-Channel HEXFET® Power MOSFETs**

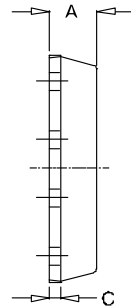
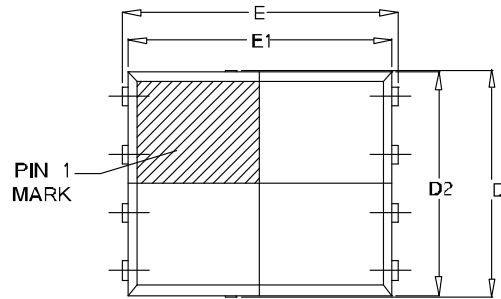


**Fig 17. Gate Charge Test Circuit**

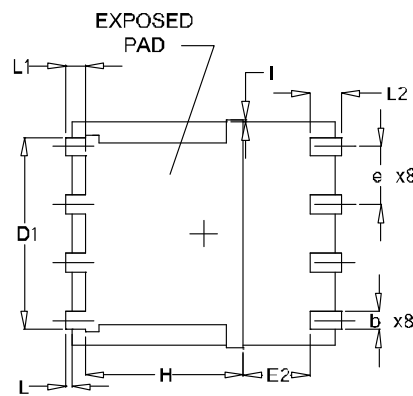


**Fig 18. Gate Charge Waveform**

## PQFN 5x6 Outline "E" Package Details

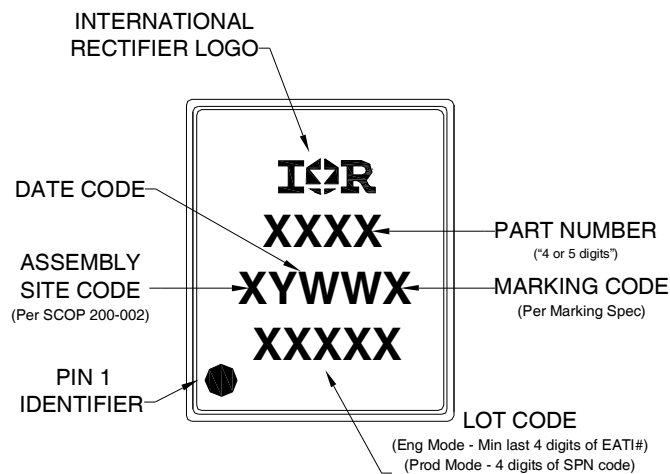

**SIDEVIEW**

**TOP VIEW**

SYMBOL	OUTLINE PQFN 5X6E		
	MIN.	NOM.	MAX.
A	0.90	1.03	1.17
b	0.33	0.41	0.48
C	0.20	0.25	0.35
D	4.80	4.98	5.15
D1	3.91	4.11	4.31
D2	4.80	4.90	5.00
E	5.90	6.02	6.15
E1	5.65	5.75	5.85
E2	1.10	—	—
e	1.27 BSC		
L	0.05	0.15	0.25
L1	0.38	0.44	0.50
L2	0.51	0.68	0.86
H	3.32	3.45	3.58
I	—	—	0.18


**BOTTOM VIEW**

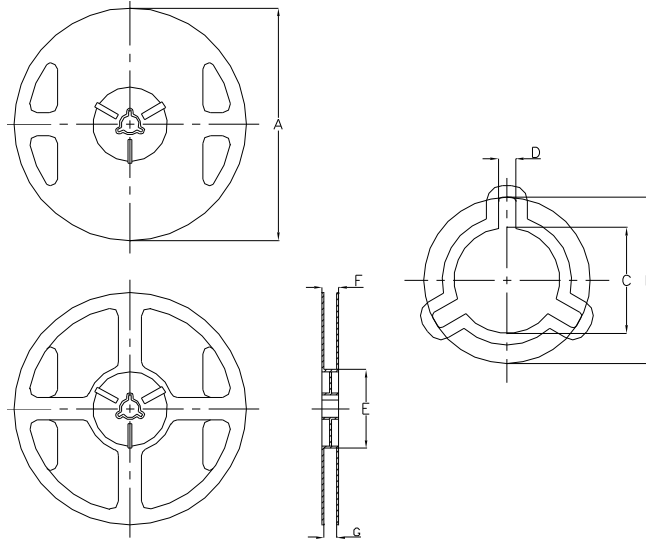
For footprint and stencil design recommendations, please refer to application note AN-1154 at <http://www.irf.com/technical-info/appnotes/an-1154.pdf>

## PQFN 5x6 Outline "E" Part Marking



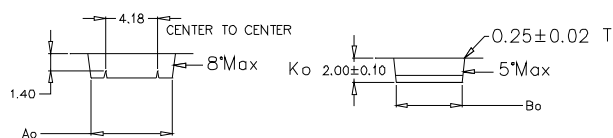
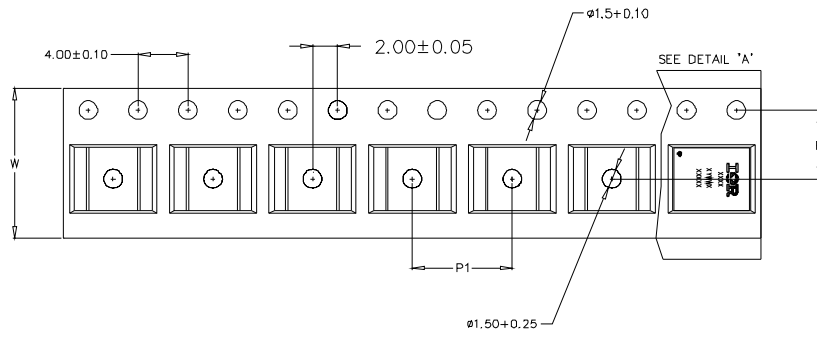
Note: For the most current drawing please refer to IR website at: <http://www.irf.com/package/>

# PQFN 5x6 Outline "E" Tape and Reel

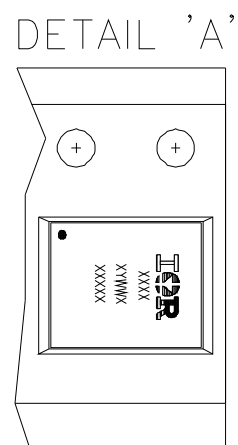


NOTE: Controlling dimensions in mm Std reel quantity is 4000 parts.

REEL DIMENSIONS								
CODE	STANDARD OPTION (QTY 4000)				TR1 OPTION (QTY 400)			
	METRIC		IMPERIAL		METRIC		IMPERIAL	
A	329.5	330.5	12.972	13.011	177.5	178.5	6.988	7.028
B	20.9	21.5	0.823	0.846	20.9	21.5	0.823	0.846
C	12.8	13.5	0.504	0.532	13.2	13.8	0.520	0.543
D	1.7	2.3	0.067	0.091	1.9	2.3	0.075	0.091
E	97	99	3.819	3.898	65	66	2.350	2.598
F	Ref	17.4			Ref	12		
G	13	14.5	0.512	0.571	13	14.5	0.512	0.571



Ao	6.50 ±0.10
Bo	5.28 ±0.10
F	5.50 ±0.05
P1	8.00 ±0.10
W	12.00 ±0.10





**Qualification information<sup>†</sup>**

Qualification level	Consumer <sup>††</sup> (per JEDEC JESD47F <sup>†††</sup> guidelines)	
Moisture Sensitivity Level	PQFN 5mm x 6mm	MSL1 (per JEDEC J-STD-020D <sup>†††</sup> )
RoHS compliant	Yes	

† Qualification standards can be found at International Rectifier's web site  
<http://www.irf.com/product-info/reliability>

†† Higher qualification ratings may be available should the user have such requirements.  
 Please contact your International Rectifier sales representative for further information:  
<http://www.irf.com/whoto-call/salesrep/>

††† Applicable version of JEDEC standard at the time of product release.

**Notes:**

- ① Repetitive rating; pulse width limited by max. junction temperature.
- ② Starting  $T_J = 25^\circ\text{C}$ ,  $L = 0.796\text{mH}$ ,  $R_G = 50\Omega$ ,  $I_{AS} = 20\text{A}$ .
- ③ Pulse width  $\leq 400\mu\text{s}$ ; duty cycle  $\leq 2\%$ .
- ④  $R_\theta$  is measured at  $T_J$  of approximately  $90^\circ\text{C}$ .
- ⑤ When mounted on 1 inch square 2 oz copper pad on 1.5x1.5 in. board of FR-4 material.
- ⑥ Calculated continuous current based on maximum allowable junction temperature.
- ⑦ Current is limited to 50A by source bonding technology.

Data and specifications subject to change without notice.

International  
 Rectifier

IR WORLD HEADQUARTERS: 101 N. Sepulveda Blvd., El Segundo, California 90245, USA Tel: (310) 252-7105  
 TAC Fax: (310) 252-7903

Visit us at [www.irf.com](http://www.irf.com) for sales contact information. 03/2012