

LOC	DIST	REVISIONS					
E	B	P	LTR	DESCRIPTION	DATE	DWN	APVD
			BA	NEW RELEASE	10-NOV-08	SM	St.P

FOR FURTHER INFORMATION SEE DATA SHEET FOR
CRG SERIES-THICK FILM CHIP RESISTORS

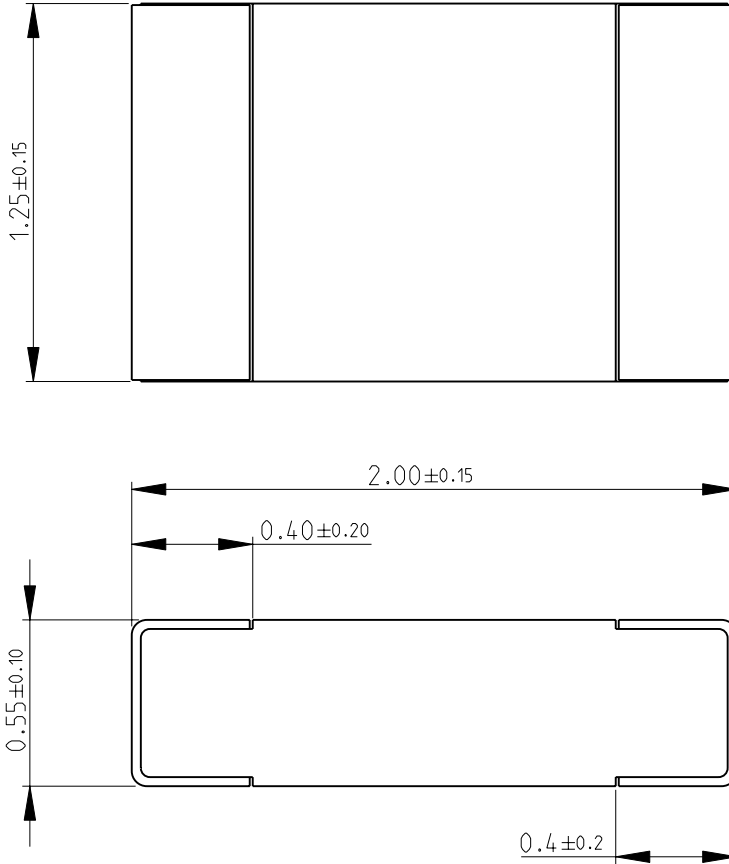

RoHS Compliant

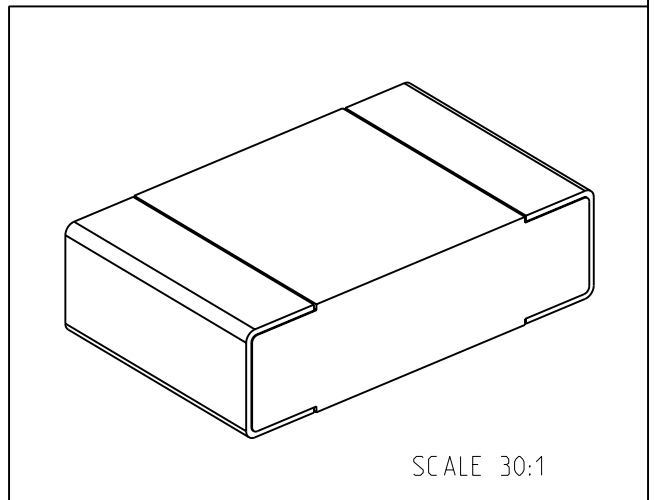

SCALE 30:1

2008

RELEASED FOR PUBLICATION

THIS DRAWING IS UNPUBLISHED.

© COPYRIGHT 2008 BY TYCO ELECTRONICS CORPORATION. ALL RIGHTS RESERVED.

DIMENSIONS: mm	DWN	10-NOV-08	MATERIAL	-	FINISH	-
	SUBHASH.M					
TOLERANCES UNLESS OTHERWISE SPECIFIED:	CHK	10-NOV-08	Tyco Electronics Corporation Dorcan, Swindon, SN3 5HH			
	PRAKASH.S					
0 PLC ±0.5	APVD	10-NOV-08	NAME THICK FILM CHIP RESISTORS SERIES CRG 0805			
1 PLC ±0.2	STEPHEN.P					
2 PLC ±0.1	PRODUCT SPEC	-	SIZE	CAGE CODE	DRAWING NO	RESTRICTED TO
3 PLC ±-	APPLICATION SPEC	-	A 4	00779	©- 1623111	-
4 PLC ±-			CUSTOMER DRAWING			
ANGLES ±5°	WEIGHT	-	SCALE	40:1	SHEET	1 OF 1
			REV BA			