

# C1005C0G2A331K050BA

TDK Item Description : C1005C0G2A331KT\*\*\*\*



## Application & Main Feature

Commercial Grade ( Mid Voltage (100 to 630V) )

## Series

C1005 [EIA CC0402]

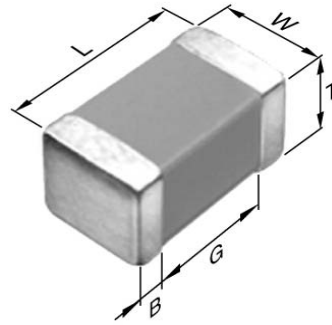

## Dimensions

L 1.00mm +/-0.05mm  
 W 0.50mm +/-0.05mm  
 T 0.50mm +/-0.05mm  
 B 0.10mm Min.  
 G 0.30mm Min.

## Temperature Characteristic

C0G (-55 to 125 degC 0+/-30ppm/degC)

## Rated Voltage

2A (100Vdc)

## Capacitance

330pF

## Capacitance Tolerance

K (+/-10%)

## Q Factor

1000 Min.

## Insulation Resistance

10Gohm Min.

## AEC-Q200

Not Applicable

**|Z|, ESR vs. Freq. Characteristics**

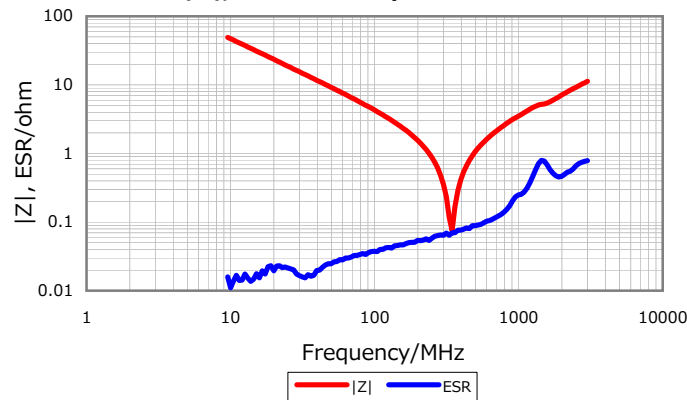

**DC Bias Characteristic**



**Cap. vs. Freq. Characteristic**

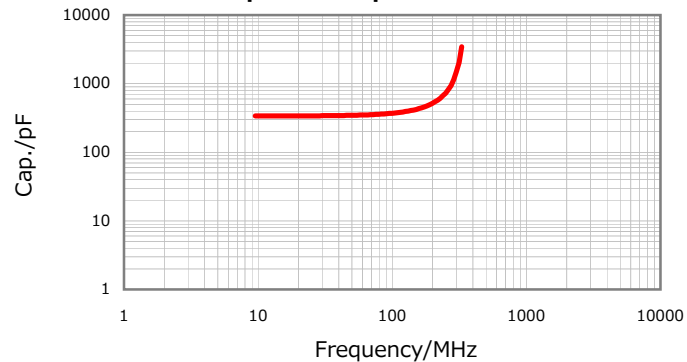

**Temperature Characteristics**



Characterization Sheet ( Multilayer Ceramic Chip Capacitors )



All specifications are subject to change without notice.

January 3, 2016